

National Grid Infrastructure (NGI)

for scientific computations, collaborative research & its support services

Tomáš Rebok

CERIT-SC, Institute of Computer Science MU

MetaCentrum, CESNET z.s.p.o.

(rebok@ics.muni.cz)

National Grid Infrastructure (NGI)

National Grid Infrastructure (NGI)

- operated by MetaCentrum NGI (CESNET) since 1996
- MetaCentrum responsible for management and coordination

Distributed infrastructure

NGI integrates medium/large HW centers (clusters, powerful servers, storages) of several universities/institutions

- further integrated into the European Grid Infrastructure (EGI.eu)

<http://www.metacentrum.cz>

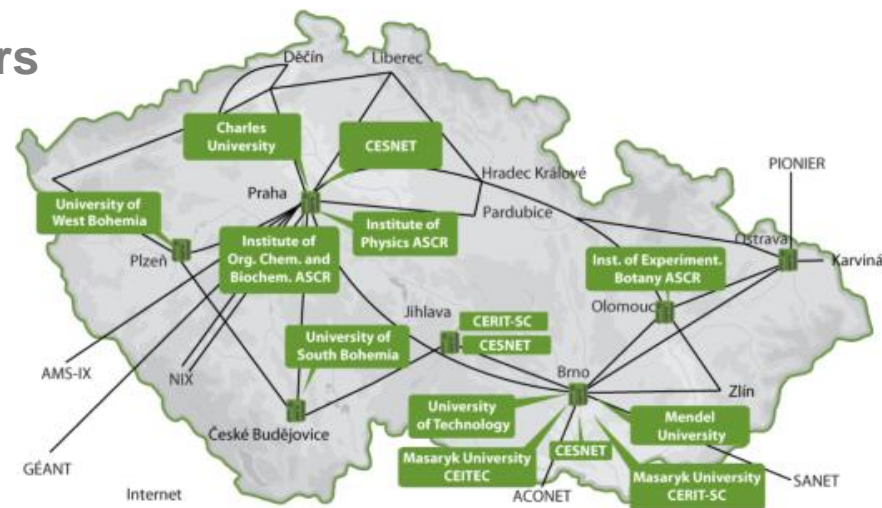

Computing clusters

a set of interconnected („common“) computers



(oldschool)

Computing clusters

a set of interconnected („common“) computers



(nowadays)

MetaCentrum NGI & Resource integration I.

■ MetaCentrum and CERIT-SC

- MetaCentrum provides own HW resources (CESNET) and integrates resources of external providers
 - CERIT-SC/MUNI is one of them
 - others are CEITEC/NCBR, FZU, ČVUT, JČU, ZČU, UPOL, MU, TUL, etc.
 - as well as global projects like ELIXIR CZ

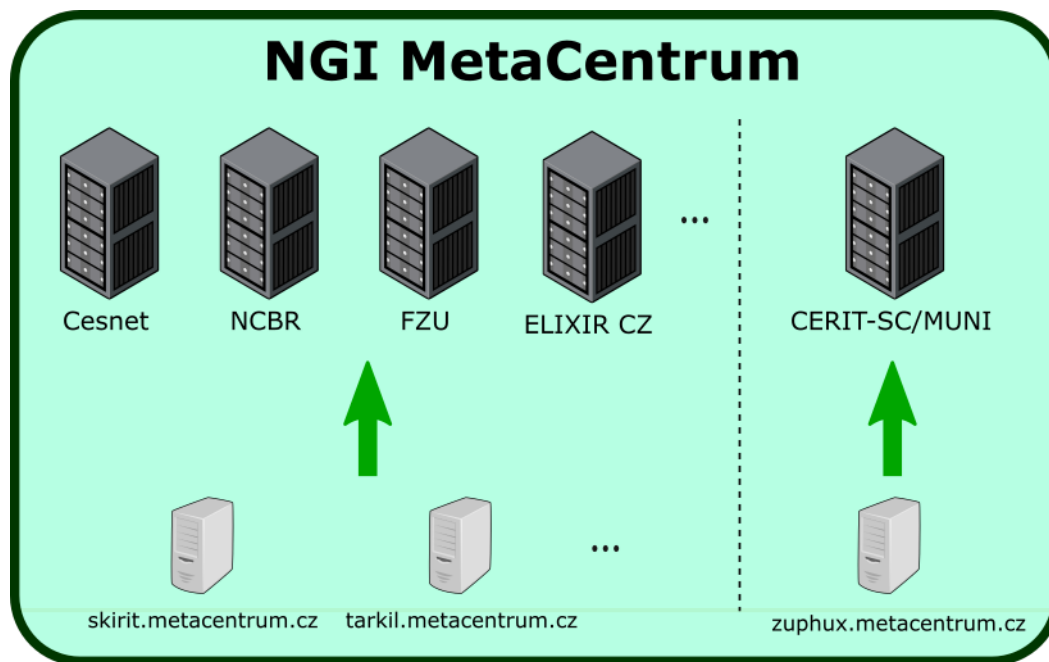

**+ shared storages
and shared SW apps**

MetaCentrum NGI & Resource integration II.

- **resource owners (usually) have priority access to their HW resources**
 - under agreed conditions
 - technically accomplished using **specific scheduler queues**
 - more details later

MetaCentrum NGI

Available to all academic users from Czech universities, Academy of Science, research institutes, etc.

- commercial bodies just for public research

Offers:

- **computing resources**
- **storage resources**
- **application programs**

<http://metavo.metacentrum.cz>

After registration, all the resources/services are available free of charge

- without any administrative burden
- users “pay” via publications with acknowledgements
→ results in user priorities in cases of high load



Meta NGI – basic characteristics

- after registration, all the resources are available **without any administrative burden**
 - → ~ immediately (depending on actual usage)
 - **no applications for resources**
- **user accounts extensions every year**
 - **validates users' relationship to an academic institution**
 - federated infrastructure eduID.cz used for minimalization of users' burden
 - **reports of user publications with acknowledgements to MetaCentrum/CERIT-SC**
 - used as a proof of infrastructure benefits for Czech research area
- **best-effort service**

Meta NGI – computing resources available

Computing resources: ca 14900 cores (x86_64)

- nodes with lower number of computing cores:
2x4-8 cores
- nodes with medium number of comp. cores
(**SMP nodes**): 32-80 cores
- memory (RAM) up to **1 TB per node**
- nodes with high number of computing cores:
SGI UV2000
 - 384 cores (x86_64), 6 TB of RAM
 - 288 cores (x86_64), 6 TB of RAM
- other „exotic“ hardware:
 - nodes with GPU cards, SSD discs, Xeon Phi, etc.



<http://metavo.metacentrum.cz/cs/state/hardware.html>

Meta NGI – storage resources available

ca 3 PB for operational data

- centralized storage arrays distributed through various cities in the CR
- user quota 1-3 TB on each storage array

ca 22 PB for archival data

- (HSM – MAID, tapes)
- “unlimited” user quota

<http://metavo.metacentrum.cz/cs/state/nodes>

Meta NGI – software available

~ **300 different applications (commercial & free/open s.)**

– see <http://meta.cesnet.cz/wiki/Kategorie:Aplikace>

- **development tools**

– GNU, Intel, and PGI compilers, profiling and debugging tools (TotalView, Allinea), ...

- **mathematical software**

– Matlab, Maple, Mathematica, gridMathematica, ...

- **application chemistry**

– Gaussian 09, Gaussian-Linda, Gamess, Gromacs, ...

- **material simulations**

– Wien2k, ANSYS Fluent CFD, Ansys Mechanical, Ansys HPC...

- **structural biology, bioinformatics**

– CLC Genomics Workbench, Geneious, Turbomole, Molpro, ...

Meta NGI – grid environment

- *batch jobs*

- the computations described by script files

- *interactive jobs*

- text & graphical environment

- *cloud computing*

- instead of running jobs with computations, users run the whole virtual machines

focused on research computations again (not for webhosting)

Windows & Linux images provided, user-uploaded images also supported
more info later...

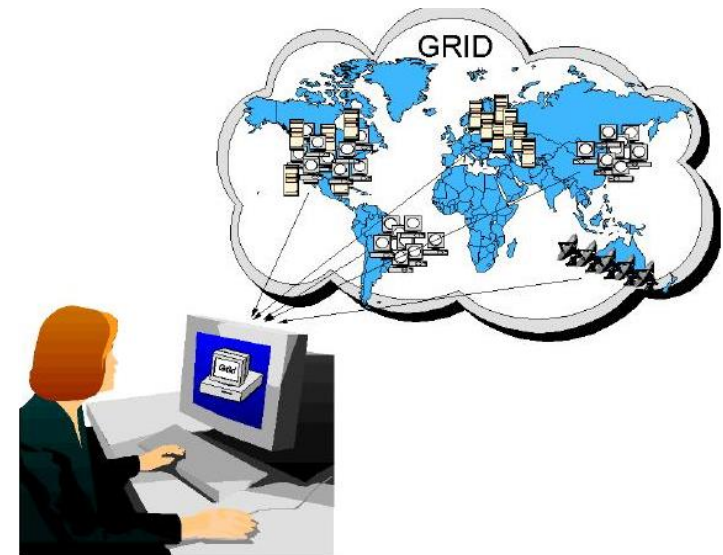

Meta VO in numbers...

- *ca 14914 cores, ca 600 server nodes*
- *year 2017:*
 - *1908 users (31.12.2017)*
 - *ca 4,76 mil. of running jobs*
 - *ca 13000 jobs per day*
 - *ca 2500 jobs per user*
 - *CPU time*
ca 10,5 thousands of CPUyears

... and graphs

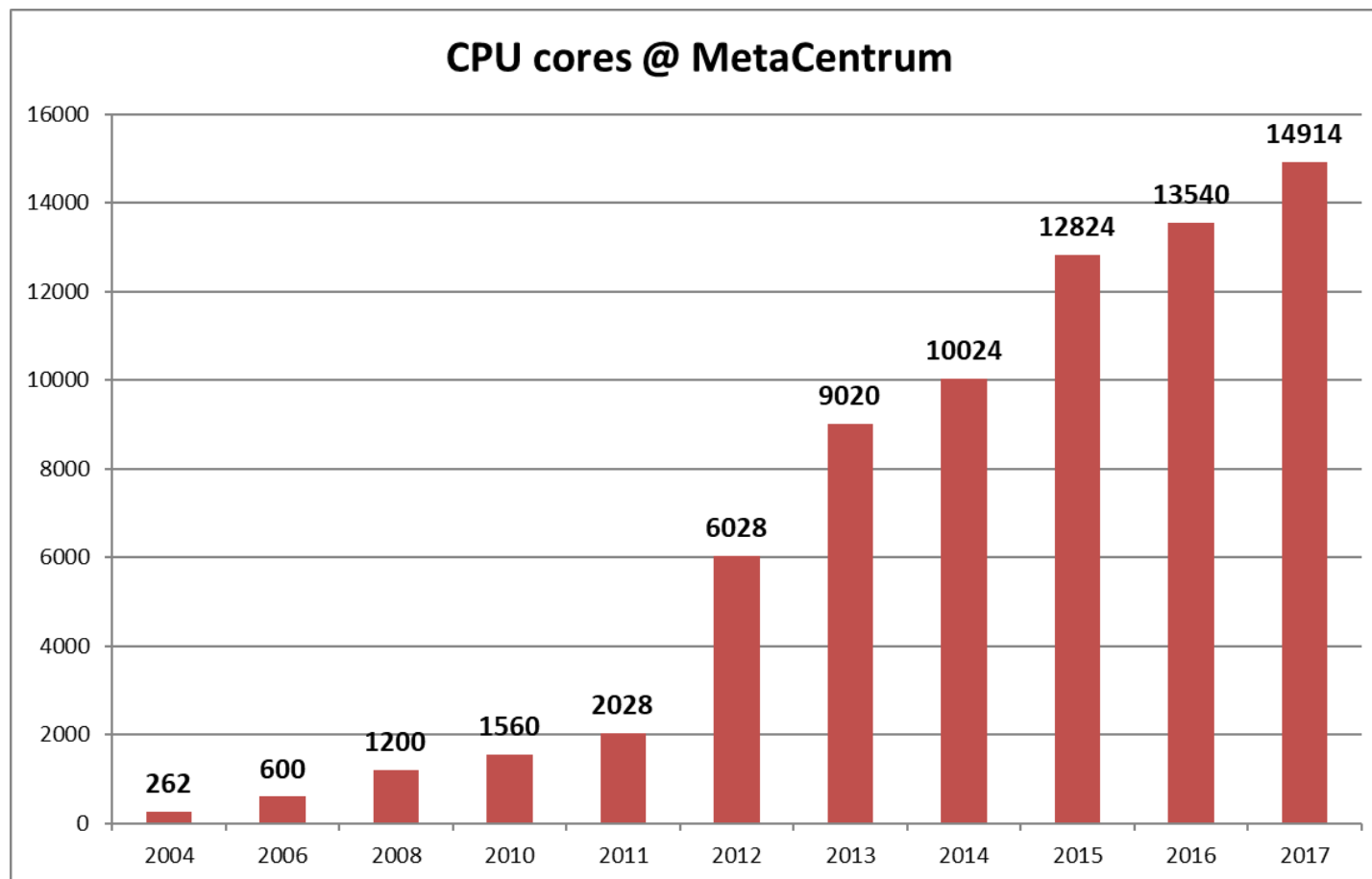

... and graphs

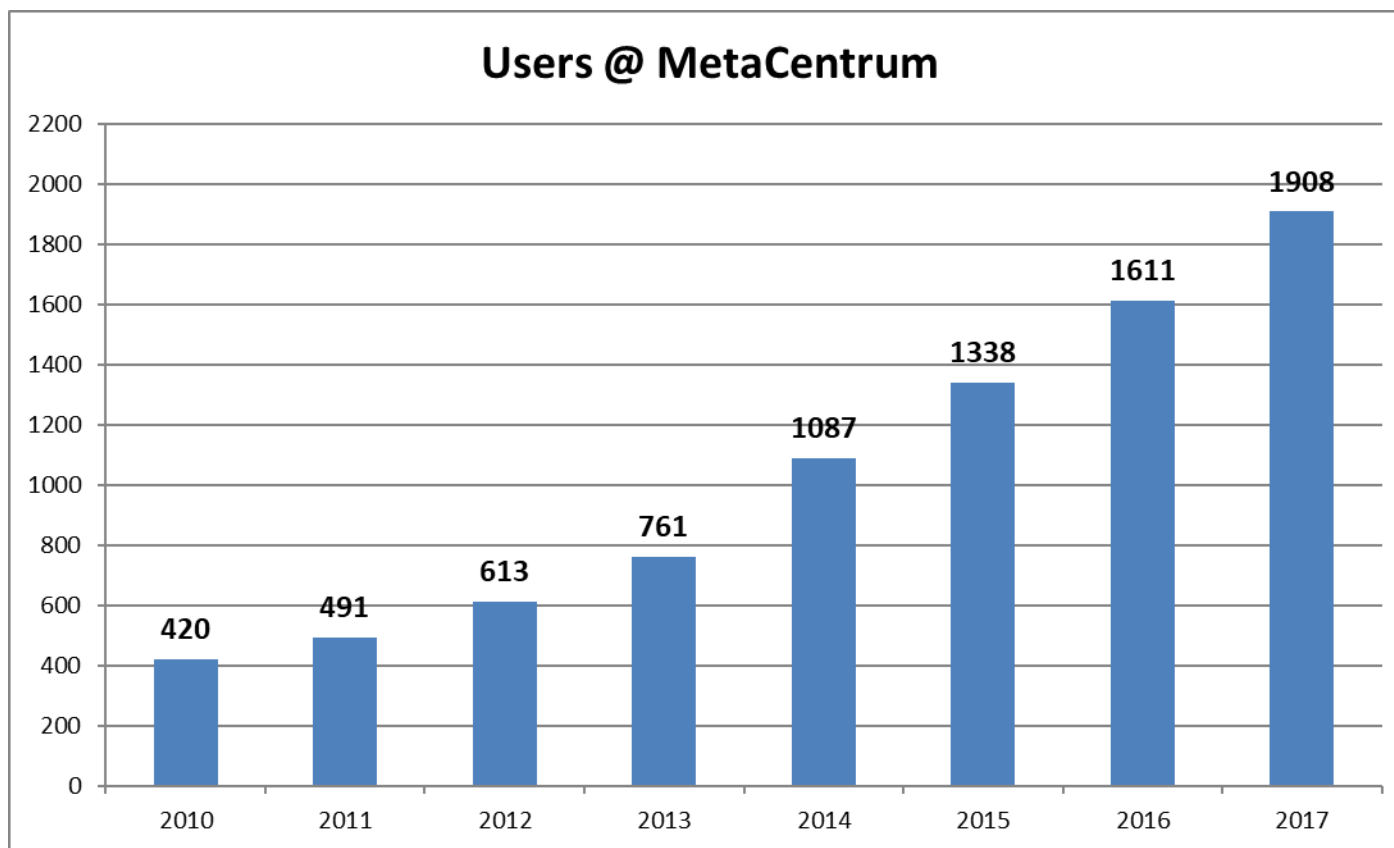

... and graphs

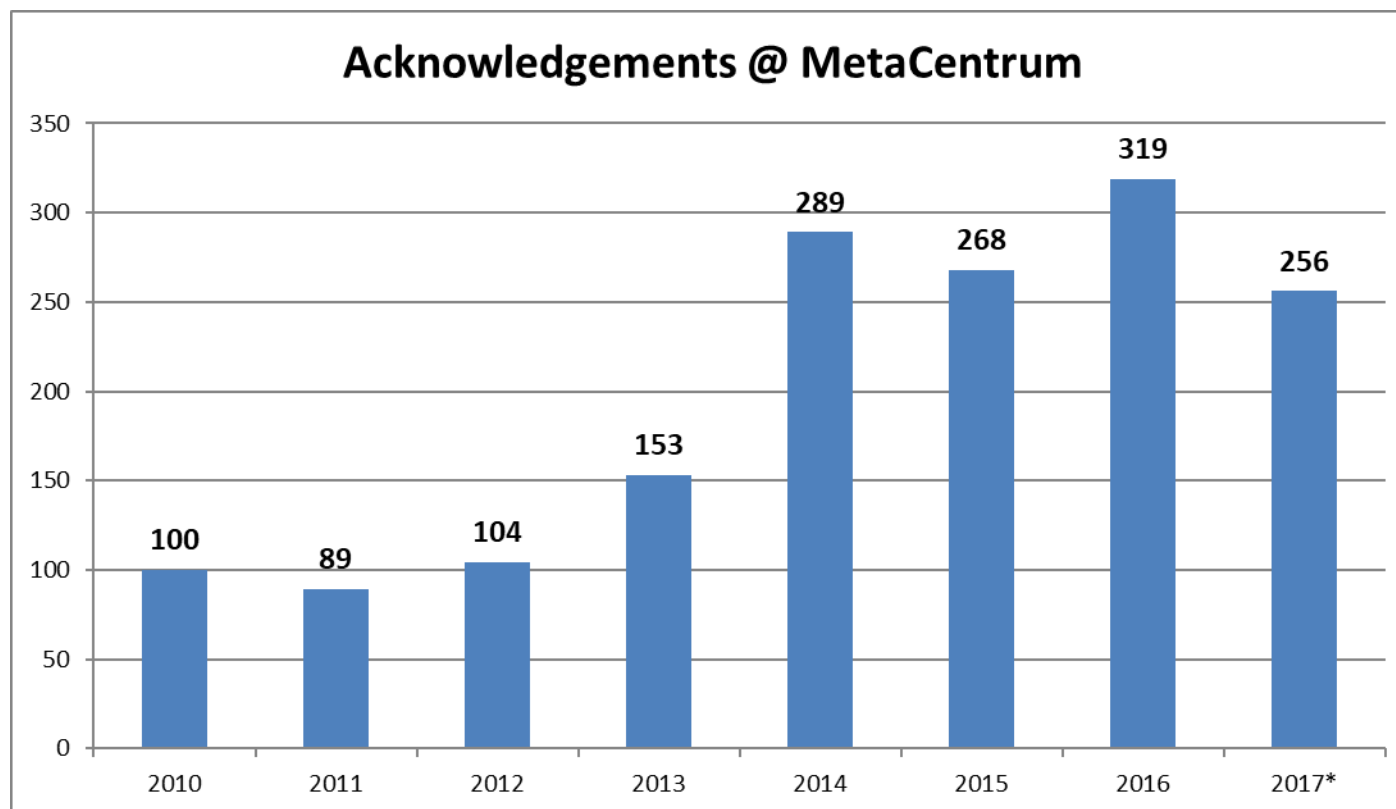

Meta VO – how to become our user?

- **register**

- <http://metavo.metacentrum.cz> , section „Application“
- EduID.cz => **proves your academic identity** using your home institution services (and credentials)

- **make yourself familiar with basics of OS Linux**

- <http://metavo.metacentrum.cz> , section „Documentation“
- <http://www.poznejlinux.cz/linuxbook/xhtmll-chunks/ch07.html>

- **compute**

Research Infrastructures in CR I.

- *IT4innovations (Ostrava)*

- **3344 computing cores** („small“ supercomputer/cluster)
- **24192 computing cores** („big“ supercomputer/cluster)
- attributes:
 - computing time assigned to **research projects**
 - **formal application** is necessary (evaluation of research and technical readiness + financial contributions)
 - **public competitions** 2x per year
 - if accepted, easier resource access (low number of competitive users)
- purpose:
 - large (proven) computations using homogeneous infrastructure

Research Infrastructures in CR II.

- **National Grid Infrastructure (NGI) MetaCentrum**
 - ca **15000 computing cores** (including CERIT-SC resources)
 - attributes:
 - computing time **available free of charge, without formal applications**
 - **heterogeneous resources** available (including „exotic“ ones)
 - **resources shared with competitive users** (sometimes hard to access)
 - purpose:
 - common **smaller to middle –sized computations** (larger computations after agreement)
 - **preparation of computations/projects for computations at IT4innovations** (~ technical readiness)
- **CERIT-SC @ ICS MU**
 - *HW and SW provider (resources available through NGI)*
 - **main emphasis on services supporting user research**

CERIT-SC & NGI



Centre CERIT-SC

A computing and research centre operating at Masaryk University

- long-term history (→ long-term experience in ICT science)
 - CERIT-SC evolved from Supercomputing Center Brno (established in 1994), and
 - participates on the operation of National Grid Infrastructure

Our mission:

<http://www.cerit-sc.cz>

- production services for computational science
 - high-performance computing clusters
 - large data storage, back-ups and data archives
 - web portals & projects' back-office
- an application of top-level ICT in the science
 - own research in e-infrastructures (know-how)
 - novel forms of infrastructure utilization (experimental usage support)
 - research collaborations with other science areas

Centre CERIT-SC & NGI

CERIT-SC is an important NGI partner

- **HW & SW resources provider**

 - SMP nodes (2592 cores)

 - HD nodes (2624 cores)

 - SGI UV node (288 cores, 6 TB RAM)

 - SGI UV node (384 cores, 6 TB RAM)

 - storage capacity (~ 3,5 PB)

- **significant personal overlaps
with NGI exist**

CERIT-SC (SCB) established MetaCentrum NGI

- → **much research/work is performed in collaboration**

<http://www.cerit-sc.cz>



■ Research support by CERIT-SC

Fact I. Common HW centers provide just a “dumb” power without any support how to effectively use it

Fact II. Common HW centers do not participate on the users’ research aiming to help them with ICT problems

CERIT-SC collaborates with its users:

- to help them effectively use the provided resources
 - to help them to cope with their ICT research problems
- focusing on an application of top-level ICT in the science smaller as well as bigger (= funded) projects

What's the idea?

We focus on intelligent & novel usage forms of the provided infrastructure

- the provided HW/SW resources serve just as a tool for research and development
 - highly-flexible infrastructure (convenient to experiments)
- in comparison with NGI resources, the production computations are at the second-level of interest
- the centre aims to be equipped with cutting-edge technologies in order to allow top-level research (both internal & collaborative)
- real research collaboration with our partners
 - the collaborations generate new questions/problems for IT
 - the collaborations generate novel opportunities for the science
 - (we DON'T want to be a common service organization)

■ How do we fulfill the idea?

How are the research collaborations performed?

- the work is carried via a doctoral/diploma thesis of a FI MU student
- the CERIT-SC staff supervises/consults the student and regularly meets with the research partners
- the partners provide the expert knowledge from the particular area

Collaborations through (international) projects

- CERIT-SC participates on several projects, usually developing IT infrastructure supporting the particular research area
ELIXIR-CZ, BBMRI, Thalamoss, SDI4Apps, Onco-Steer, CzeCOS/ICOS, ...
KYPO, 3M SmartMeters in cloud, MeteoPredictions, ...

Strong ICT expert knowledge available:

- long-term collaboration with Faculty of Informatics MU
- long-term collaboration with CESNET
- consultations with experts in particular areas

Selected research collaborations

Selected (ongoing) collaborations I.

3D tree reconstructions from terrestrial LiDAR scans

- partner: Global Change Research Centre - Academy of Sciences of the Czech Republic (*CzechGlobe*)
- **the goal: to propose an algorithm able to perform fully-automated reconstruction of tree skeletons (main focus on Norway spruce trees)**
 - from a 3D point cloud
 - scanned by a LiDAR scanner
 - the points provide information about XYZ coordinates + reflection intensity
 - *the expected output: 3D tree skeleton*
- **the main issue:** overlaps (\rightarrow gaps in the input data)

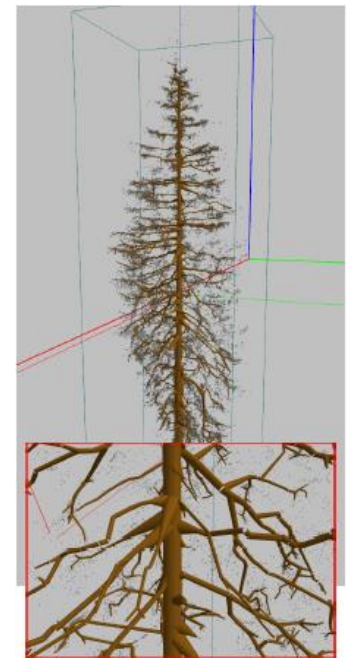

Selected (ongoing) collaborations I.

3D tree reconstructions from terrestrial LiDAR scans – cont'd

- the diploma thesis proposed a novel innovative approach to the reconstructions of 3D tree models
- the reconstructed models used in subsequent research
 - **determining a statistical information** about the amount of wood biomass and about basic tree structure
 - **parametric supplementation of green biomass** (young branches+ needles) – a part of the PhD work
 - **importing the 3D models into tools performing various analysis** (e.g., DART radiative transfer model)

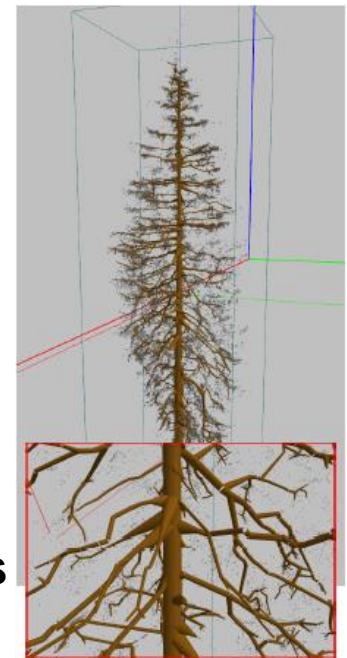

Selected (ongoing) collaborations II

3D reconstruction of tree forests from full-wave LiDAR scans

- subsequent PhD thesis, a preparation of joint project
- **the goal: an accurate 3D reconstruction of tree forests scanned by aerial full-waveform LiDAR scans**
 - possibly supplemented by hyperspectral or thermal scans, in-situ measurements,

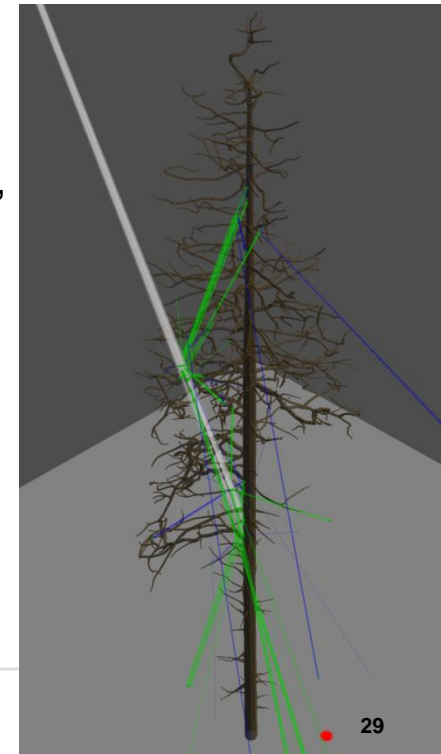
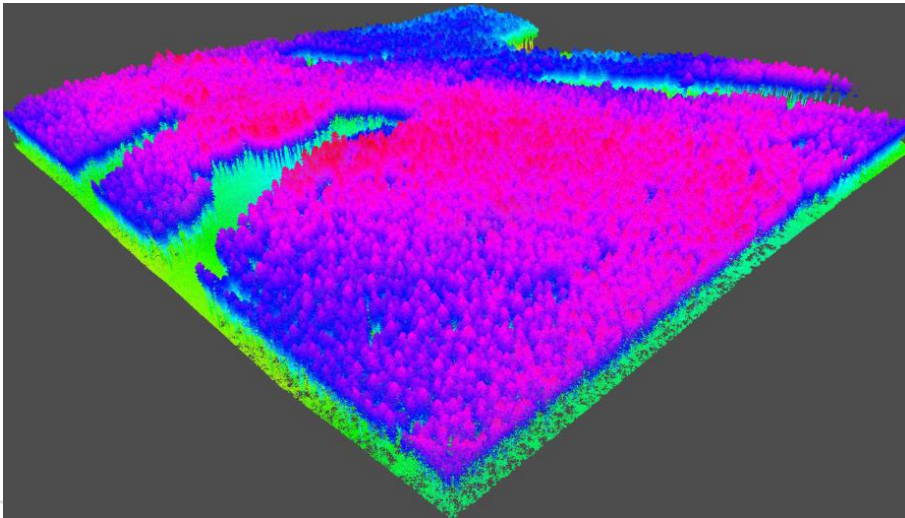

Selected (ongoing) collaborations III.

An algorithm for determination of problematic closures in a road network

- partner: *Transport Research Centre, Olomouc*
- **the goal: to find a robust algorithm able to identify all the road network break-ups and evaluate their impacts**
- **main issue: computation demands**
 - the brute-force algorithms fail because of large state space
 - 2 algorithms proposed able to cope with multiple road closures

Selected (ongoing) collaborations IV

- **An application of neural networks for filling in the gaps in eddy-covariance measurements**
 - *partner: CzechGlobe*
- **Biobanking research infrastructure (BBMRI_CZ)**
 - *partner: Masaryk Memorial Cancer Institute, Recamo*
- **Propagation models of epilepsy and other processes in the brain**
 - *partner: MED MU, ÚPT AV, CEITEC*
- **Photometric archive of astronomical images**
- **Extraction of photometric data on the objects of astronomical images**
 - *2x partner: partner: Institute of theoretical physics and astrophysics SCI MU*
- **Bioinformatic analysis of data from the mass spectrometer**
 - *partner: Institute of experimental biology SCI MU*
- **Synchronizing timestamps in aerial landscape scans**
 - *partner: CzechGlobe*
- **Optimization of Ansys computation for flow determination around a large two-shaft gas turbine**
 - *partner: SVS FEM*
- **3.5 Million smartmeters in the cloud**
 - *partner: CEZ group, MycroftMind*
- ...

**Additional services available
to academic research community**

Data services

Hierarchical data storages

- 22+ PB of physical capacity
- useful for data archivals, backups, etc.
- various access protocols available

Further end-user services

- FileSender
- OwnCloud

<http://du.cesnet.cz>

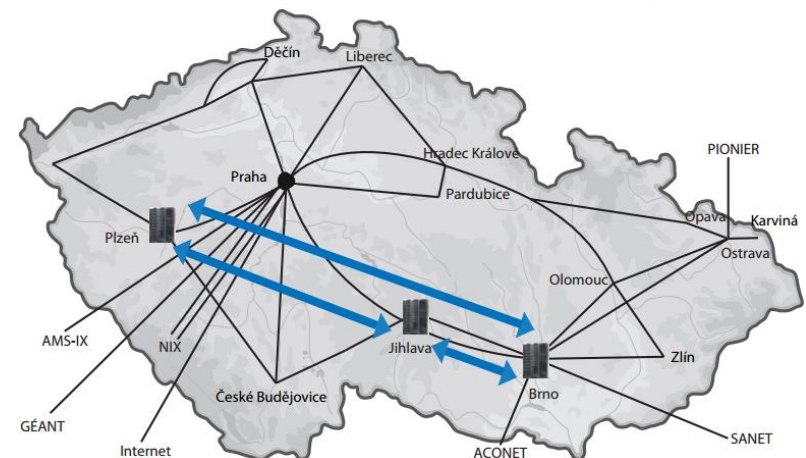

Data Services for end-users

- ***FileSender*** – file sharing/transferring service
 - web service intended for sending big data files
 - big = current limit is 500 GB
 - <http://filesender.cesnet.cz>
 - at least one user has to be an authorized infrastructure user
 - federated authentication through eduID.cz
 - authorized user is allowed to **upload a file** (and **send a notification to the receiver**)
 - if an authorized user needs to **receive data from a non-authorized user**, she sends him **an invitation link** (so he is allowed to use it for uploading the file)

FileSender – example I.



The screenshot shows the FileSender website interface. At the top left is the FileSender logo, which includes a yellow truck icon and the text "FILESENDER" with a red chili pepper. To the right, it says "an initiative by" followed by logos for aarnet, UNINETT, HEAnet, and SURF NET. Below these are two buttons: "Pomoc" and "O programu". A status bar indicates: "| UP: 1820 files (2305GB) | DOWN: 2065 files (1876GB) | 1.5-rc1 HTML 5 ✓". The main content area has the heading "Vítejte na FileSender" and the text: "FileSender je bezpečná cesta pro sdílení velkých souborů mezi všemi! Přihlaš se a nahraj své soubory nebo pozvi ostatní, ať soubory nahrají oni." Below this text is a "Přihlásit" button. A large grey arrow points from the right side of the page towards the "Přihlásit" button. At the bottom center is the CESNET logo.

FileSender – example II.



eduID.cz + 

[O federaci](#) | [Politika](#) | [Kontakt](#) | [Nápověda](#)

Zvolte svou domovskou organizaci

Přístup ke zdroji na serveru '**filesender.cesnet.cz**' vyžaduje autentizaci.

Uložit tuto volbu do ukončení relace prohlížeče.
 Uložit tuto volbu nastálo.

Operátorem federace [eduID.cz](#) je [CESNET, z.s.p.o.](#)



 **CESNET**

Přihlášení

Uživatelské jméno

Heslo

FileSender – example III.



 FILESENDER 

— an initiative by —
 aarnet  UNIUNET  HEAnet  SURF NET

Nahrát nový soubor Pozvánky Mé soubory Pomoc O programu Odhlásit

Vítejte Tomáš Košňar | UP: 1820 files (2305GB) | DOWN: 2065 files (1876GB) | 1.5-rc1 HTML 5 ✓

Nahrát soubor

Příjemce:

Odesílatel: tomas.kosnar@cesnet.cz

Předmět: (volitelné)

Zpráva: (volitelné)

Datum expirace:

Vyberte soubor: Soubor nevybrán

Souhlasím s podmínkami užití této služby.
[Zobrazit/Skrýt]



OwnCloud

- **cloud storage „like Dropbox“**
 - quota: 100 GB / user
 - available through web interface
 - <https://owncloud.cesnet.cz/>
 - clients for Windows, Linux, OS X
 - clients for smartphones and tablets
 - allows sharing among a group of users
 - data backups every day
 - document versioning
 - calendars and contacts sharing
 - etc.













OwnCloud – example I.



OwnCloud – example II.

Přihlásit účtem

České vysoké učení technické v Praze, Fakulta elektrotechnická	
CESNET	
Masarykova univerzita	
Univerzita Hradec Králové	
Univerzita Pardubice	
Západočeská univerzita v Plzni	
Jiný účet	

   CESNET 

OwnCloud – example III.

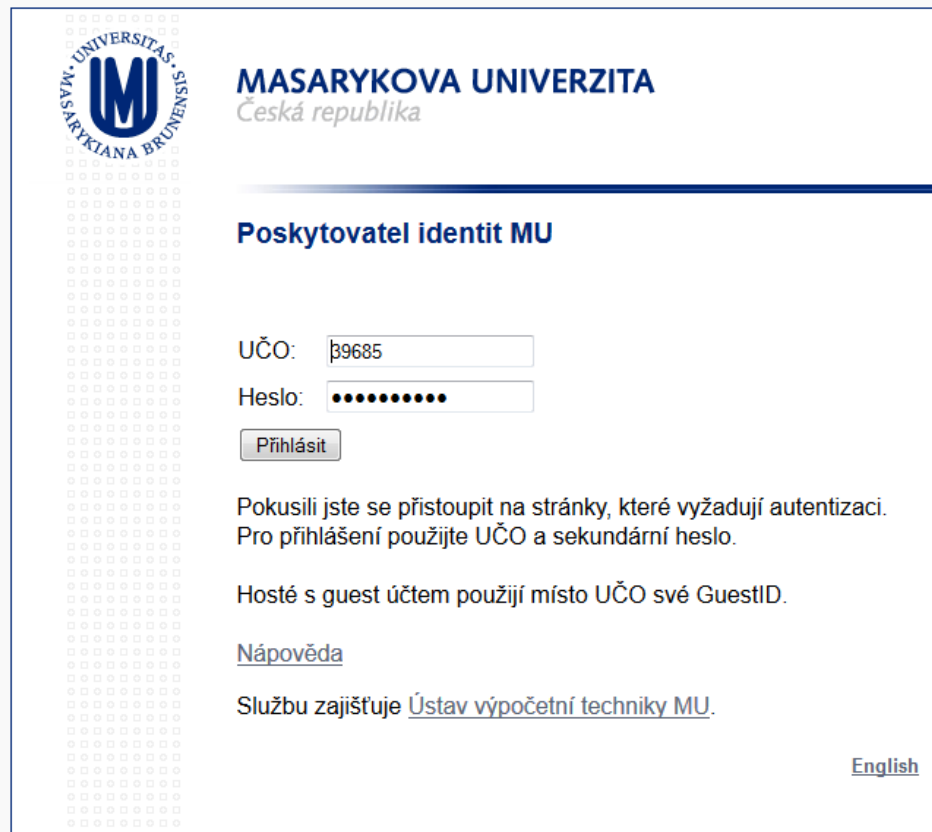

The screenshot shows the login page for Masaryk University. On the left is the university's logo, a circular emblem with 'UNIVERSITAS SILENSIS MASARYKIANA BRUNNENSIS' and a large 'M'. To the right of the logo, the text reads 'MASARYKOVA UNIVERZITA' and 'Česká republika'. Below this is a horizontal line and the heading 'Poskytovatel identit MU'. There are two input fields: 'UČO:' with the value 'β9685' and 'Heslo:' with a masked password of ten dots. A 'Přihlásit' button is below the password field. Further down, there is explanatory text in Czech: 'Pokusili jste se přistoupit na stránky, které vyžadují autentizaci. Pro přihlášení použijte UČO a sekundární heslo.' and 'Hosté s guest účtem použijí místo UČO své GuestID.' There is a link for 'Nápověda' and another for 'Službu zajišťuje Ústav výpočetní techniky MU.' At the bottom right, there is a link for 'English'.

OwnCloud – example IV.

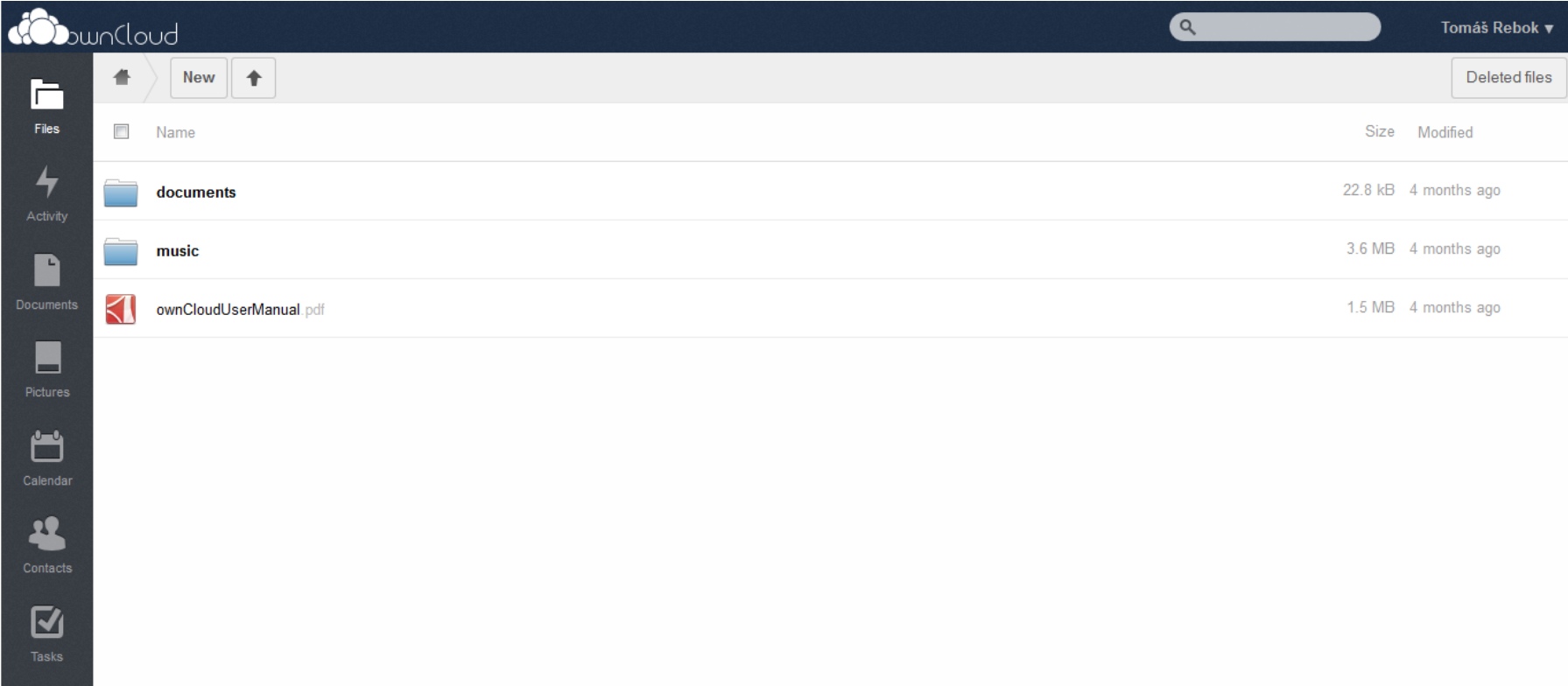

The screenshot displays the OwnCloud web interface. At the top, there is a search bar and the user name "Tomáš Rebok". Below the search bar, there are navigation buttons for "New" and "Upload". The main content area shows a table of files and folders:

Name	Size	Modified
documents	22.8 kB	4 months ago
music	3.6 MB	4 months ago
 ownCloudUserManual.pdf	1.5 MB	4 months ago

The left sidebar contains navigation icons for Files, Activity, Documents, Pictures, Calendar, Contacts, and Tasks.

Remote collaboration support

Support for interactive collaborative work in real-time

- **videoconferences**
HD videoconferencing support via H.323 HW/SW equipment
- **webconferences**
SD videoconferencing support via Adobe Connect (Adobe Flash)
<http://meetings.cesnet.cz>
- **special transmissions**
HD, UHD, 2K, 4K, 8K with compressed/uncompressed video transmission (UltraGrid tool)
- **IP telephony**

Support for offline content access

- **streaming**
- **video archive**

<http://vidcon.cesnet.cz>



Security services

Security incidents handling

- detailed monitoring of possible security incidents
- the users/administrators are informed about security incidents, and
- helped to resolve the incident
- additional services:
seminars, workshops, etc.

Security teams CSIRT-MU and CESNET-CERTS

- several successes:
e.g., Chuck Norris botnet discovery



Federated identity management

Czech academic identity federation eduID.cz

- provides means for inter-organizational identity management and access control to network services, while respecting the privacy of the users
- users may access multiple applications using just a single password
- service provider administrators do not have to preserve user's credentials and implement authentication
- user authentication is always performed at the home organization, user credentials are not revealed to the service providers



<http://www.eduid.cz>

PKI – users and servers certificates

CESNET CA certification authority

- provides the users with TERENA (Trans-European Research and Education Networking Association) certificates
 - usable for electronic signatures as well as for encryption
- **CESNET CA services:**
 - issues personal certificates
 - issues certificates for servers and services
 - certificates registration offices
 - certificates certification offices

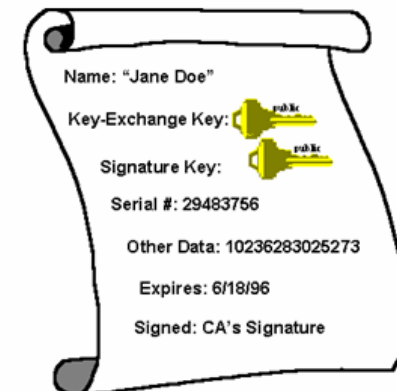

Mobility and roaming support

Euroam.cz

- idea to enable transparent usage of (especially wireless) networks of partner (Czech as well as abroad) institutions



<http://www.eduroam.cz>

Communication infrastructure and its monitoring

The basis of all the services: high-speed computer network

- 100 Gbps, called CESNET2
- interconnected with pan-european network GÉANT

and its monitoring

- detailed network monitoring (quality issues as well as individual nodes behaviour) available
- automatic detection of various events, anomalies, etc.

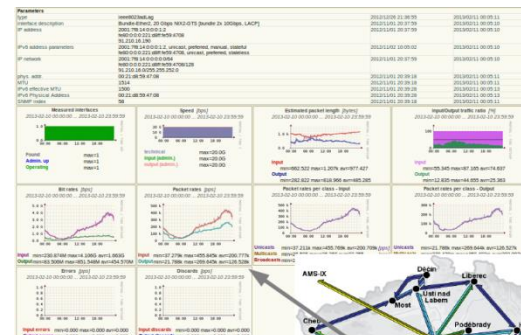
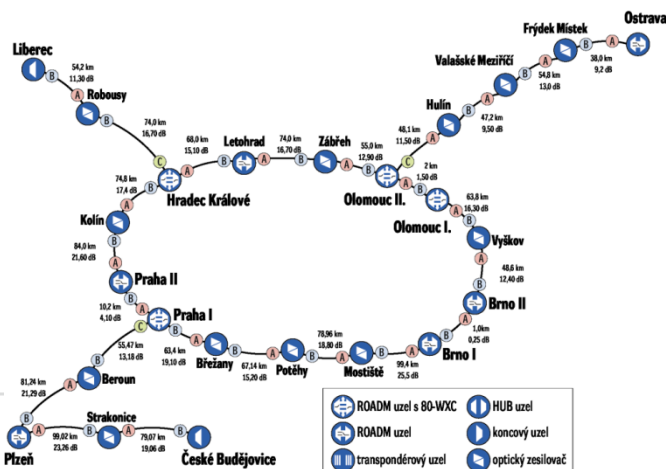

Conclusions

Conclusions

- **CESNET infrastructure:**
 - *computing services (MetaCentrum NGI & MetaVO)*
 - *data services (archivals, backups, data sharing and transfers, ...)*
 - *remote collaborations support services (videoconferences, webconferences, streaming, ...)*
 - *further supporting services (...)*
 - **Centrum CERIT-SC:**
 - *computing services (flexible infrastructure for production and research)*
 - *services supporting collaborative research*
 - *user identities/accounts shared with the CESNET infrastructure*
 - *The message: „If you cannot find a solution to your specific needs in the provided services, let us know - we will try to find the solution together with you...“*
-



The CERIT Scientific Cloud project (reg. no. CZ.1.05/3.2.00/08.0144) is supported by the *Operational Program Research and Development for Innovations*, priority axis 3, subarea 2.3 *Information Infrastructure for Research and Development*.

<http://metavo.metacentrum.cz>

<http://www.cerit-sc.cz>

Hands-on training for MetaCentrum/CERIT-SC users

Tomáš Rebok

MetaCentrum, CESNET

CERIT-SC, Masaryk University

rebok@ics.muni.cz

Overview

- Introduction
 - **MetaCentrum / CERIT-SC infrastructure overview**
 - How to ... specify requested resources
 - How to ... run an interactive job
 - How to ... use application modules
 - How to ... run a batch job
 - How to ... determine a job state
 - Another mini-HowTos ...
 - What to do if something goes wrong?
-
- Real-world examples
 - Appendices

Infrastructure overview

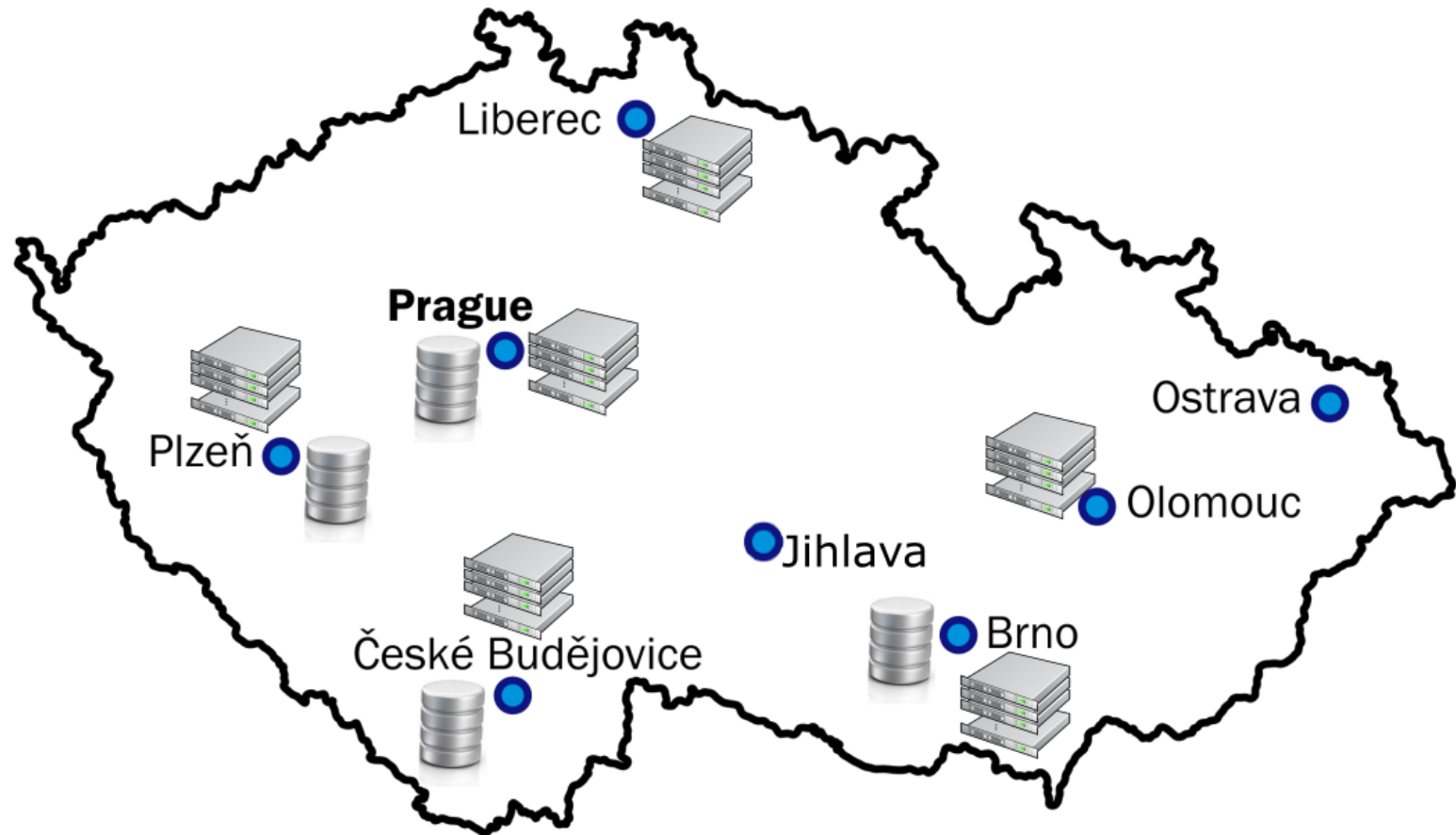

Infrastructure Access

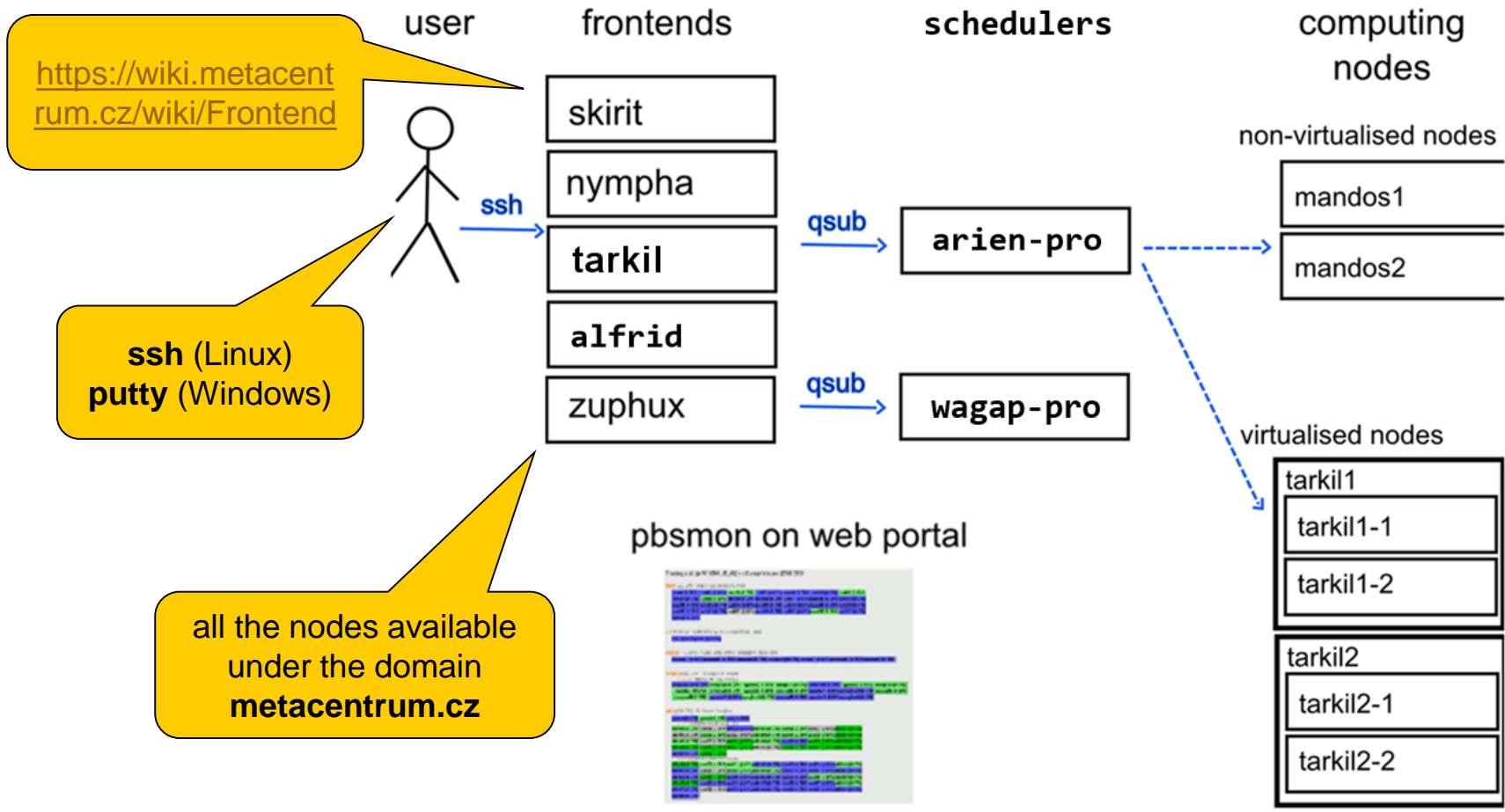

Infrastructure System Specifics

frontends, computing nodes

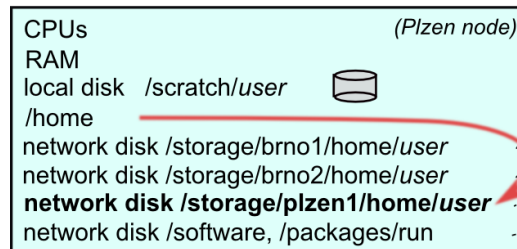
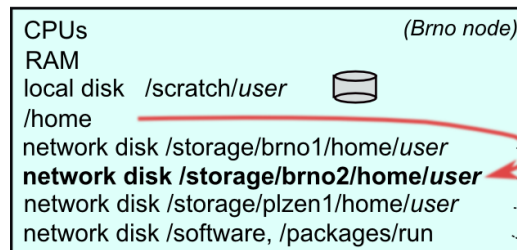
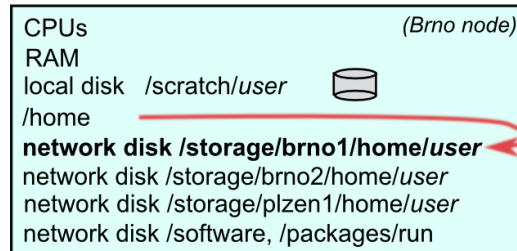

storage frontends

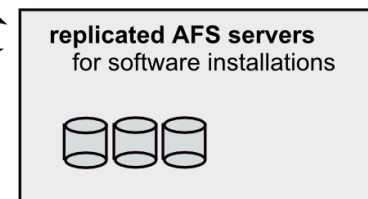
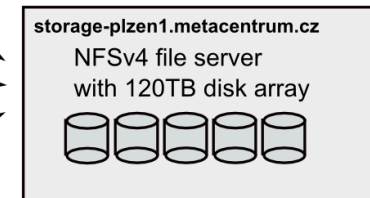

Overview

- Introduction
 - MetaCentrum / CERIT-SC infrastructure overview
 - **How to ... specify requested resources**
 - How to ... run an interactive job
 - How to ... use application modules
 - How to ... run a batch job
 - How to ... determine a job state
 - Another mini-HowTos ...
 - What to do if something goes wrong?
-
- Real-world examples
 - Appendices

How to ... specify requested resources I.

- before running a job, one needs to know **what resources the job requires**
 - and how much/many of them
- for example:
 - number of **nodes**
 - number of **CPUs/cores per node**
 - an **upper estimation** of job's runtime
 - amount of **free memory**
 - amount of **scratch space** for temporal data
 - number of requested **software licenses**
 - etc.
- the resource requirements are then **provided to the qsub utility** (when submitting a job)
 - the requested resources are **reserved for the job** by the infrastructure scheduler
 - the computation is allowed to use them
- **details about resources' specification:**
https://wiki.metacentrum.cz/wiki/About_scheduling_system

How to ... specify requested resources II.

Graphical way:

- *qsub assembler*: https://metavo.metacentrum.cz/pbsmon2/qsub_pbspro
- allows to:
 - graphically specify the requested resources
 - check, whether such resources are available
 - generate command line options for *qsub*
 - check the usage of MetaVO resources

Textual way:

- **more powerful** and (once being experienced user) **more convenient**
- see the following slides/examples →

PBS Professional – the infrastructure scheduler

- a novel scheduling system used in MetaCentrum NGI
 - see advanced information at https://wiki.metacentrum.cz/wiki/Prostředí_PBS_Professional

New term – CHUNK:

- *chunk* = further indivisible set of resources allocated to a job on a physical node
- contains *resources*, which could be asked from the infrastructure nodes
- for simplicity reasons: ***chunk = node***
 - later, we will generalize...

How to ... specify requested resources III.

Chunk(s) specification:

- *general format*: `-l select=...`

Examples:

- 2 chunks/nodes:
 - `-l select=2`
- 5 chunks/nodes:
 - `-l select=5`
- by default, allocates just a single core in each chunk
 - → should be used together with **number of CPUs (NCPUs)** specification
- if “`-l select=...`” is not provided, just a single chunk with a single CPU/core is allocated

How to ... specify requested resources IV.

Number of CPUs (NCPUs) specification (in each chunk):

- *general format:* `-l select=...:ncpus=...`

- 1 chunk with 4 cores:

- `-l select=1:ncpus=4`

- 5 chunks, each of them with 2 cores:

- `-l select=5:ncpus=2`

(Advanced chunks specification:)

- *general format:* `-l select=[chunk_1] [+chunk_2] ... [+chunk_n]`

- 1 chunk with 4 cores and 2 chunks with 3 cores and 10 chunks with 1 core:

- `-l select=1:ncpus=4+2:ncpus=3+10:ncpus=1`

How to ... specify requested resources V.

Other useful features:

- chunks from just a **single (specified) cluster** (suitable e.g. for MPI jobs):
 - *general format:* `-l select=...:cl_<cluster_name>=true`
 - e.g., `-l select=3:ncpus=1:cl_doom=true`
- chunks located in a **specific location** (suitable when accessing storage in the location)
 - *general format:* `-l select=...:<brno|plzen|praha|...>=true`
 - e.g., `-l select=1:ncpus=4:brno=true`
- **exclusive node(s) assignment** (useful for testing purposes, all resources available):
 - *general format:* `-l select=... -l place=exclhost`
 - e.g., `-l select=1 -l place=exclhost`
- **negative specification:**
 - *general format:* `-l select=...:<feature>=false`
 - e.g., `-l select=1:ncpus=4:hyperthreading=false`
- ...

A list of nodes' features can be found here: <http://metavo.metacentrum.cz/pbsmon2/props>

How to ... specify requested resources VI.

Specifying memory resources (default = 400mb):

- *general format:* `-l select=...:mem=...<suffix>`
 - e.g., `-l select=...:mem=100mb`
 - e.g., `-l select=...:mem=2gb`

Specifying job's maximum runtime (default = 24 hours):

- it is necessary to specify an upper limit on job's runtime:
- *general format:* `-l walltime=[[hh:]mm:]ss`
 - e.g., `-l walltime=13:00`
 - e.g., `-l walltime=2:14:30`

How to ... specify requested resources VII.

Specifying requested scratch space:

- useful, when the application performs **I/O intensive operations** OR for **long-term computations** (reduces the impact of network failures)
- requesting scratch is **mandatory** (no defaults)
- ***scratch space specification*** : `-l select=...:scratch_type=...<suffix>`
 - e.g., `-l select=...:scratch_local=500mb`

Types of scratches:

- ***scratch_local***
- ***scratch_ssd***
- ***scratch_shared***

Why to use scratches?

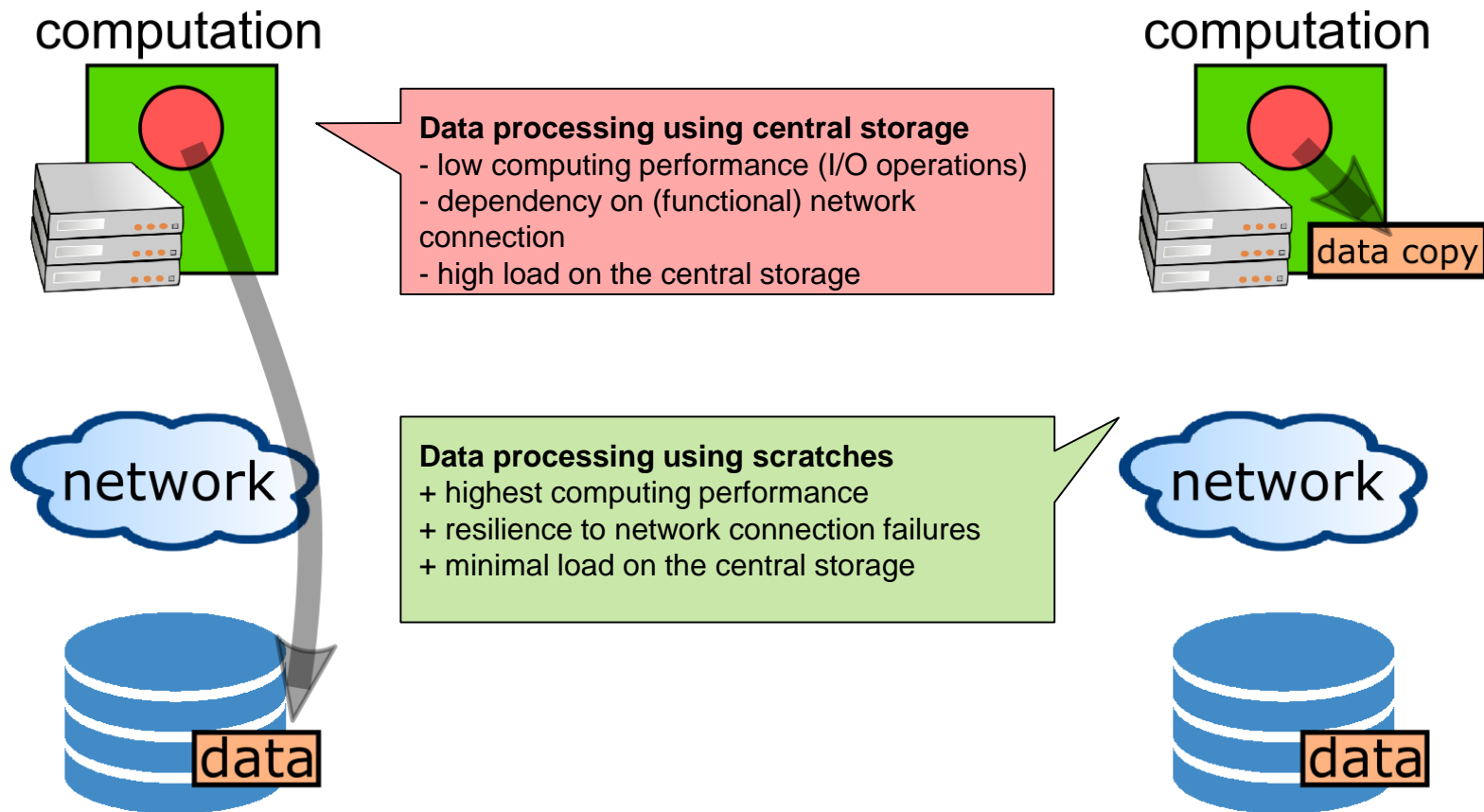

How to use scratches?

- there is a **private scratch directory for particular job**
 - `/scratch/$USER/job_$PBS_JOBID` directory for (local) job's scratch
 - `/scratch.ssd/$USER/job_$PBS_JOBID` for job's scratch on SSD
 - `/scratch.shared/$USER/job_$PBS_JOBID` for shared job's scratch
 - the master directory `/scratch*/$USER` is not available for writing
- **to make things easier, there is a `SCRATCHDIR` environment variable** available in the system
 - (within a job) points to the assigned scratch space/location

Please, clean scratches after your jobs

- there is a “`clean_scratch`” utility to perform safe scratch cleanup
 - also reports scratch garbage from your previous jobs
 - usage example will be provided later

How to ... specify requested resources VIII.

Specifying requested software licenses:

- necessary when an application requires a SW licence
 - the job becomes started once the requested licences are available
 - the information about a licence necessity is **provided within the application description** (see later)
- *general format*: `-l <lic_name>=<amount>`
 - e.g., `-l matlab=2`
 - e.g., `-l gridmath8=20`

(advanced) Dependencies among jobs

- allows to create a workflow
 - e.g., to start a job once another one successfully finishes, breaks, etc.
- see qsub's "**-w**" option (man qsub)
 - e.g., `$ qsub ... -W depend=afterok:12345.arien-pro.ics.muni.cz`

Resource chunks vs. nodes

How do chunks correspond to nodes?

- chunks arrangement – option „-l place=...“
 - l place=free: chunks are **free to spread** over available nodes
 - default behaviour
 - l place=pack: all chunks will be allocated **on the same node**
 - the node has to have enough resources available
 - l place=scatter: each chunk will be allocated **on a different node**

select=4:ncpus=2:mem=5g:scratch_local=10g

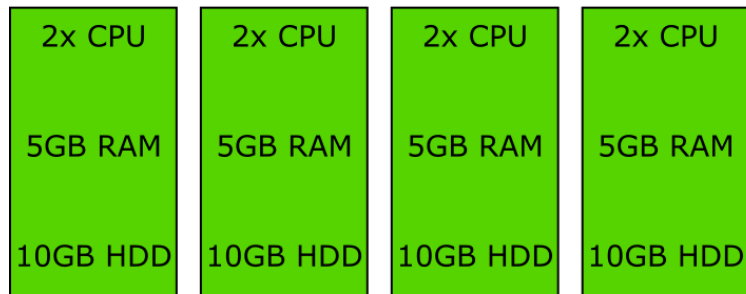

Chunks arrangement

- free vs. pack vs. scatter

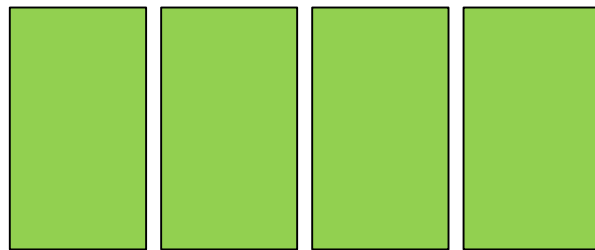

arrangement (free/pack/scatter)

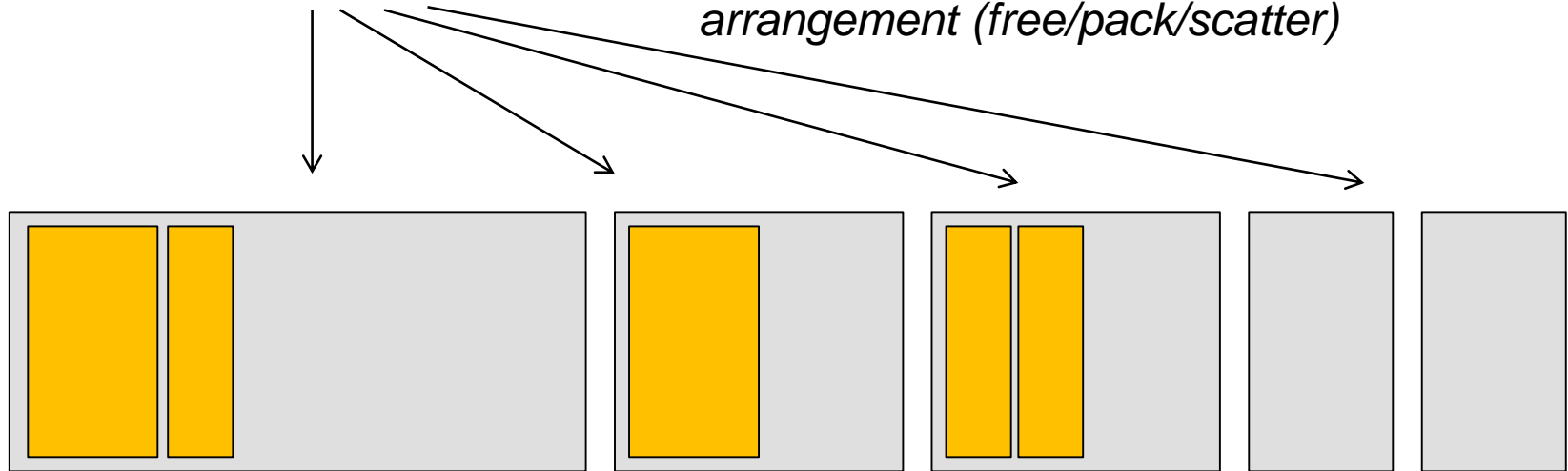

Chunks arrangement

- free vs. pack vs. scatter

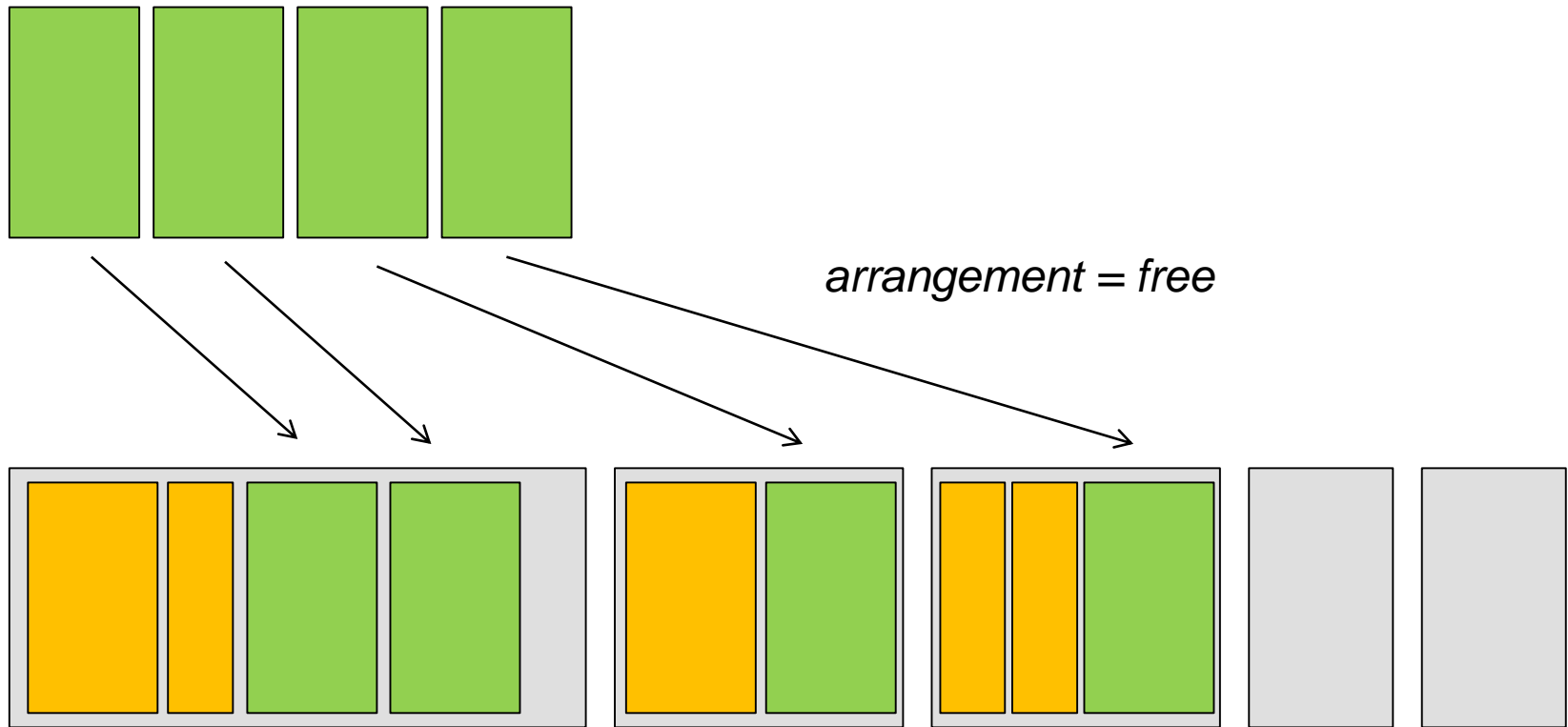

Chunks arrangement

- free vs. pack vs. scatter

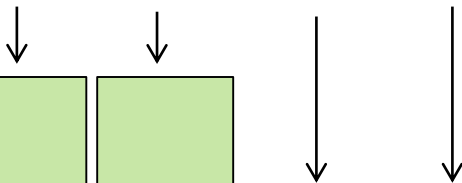
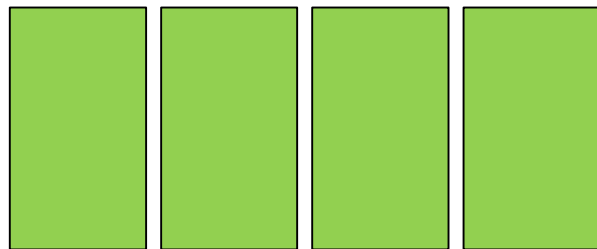

arrangement = pack

Collision
with
running
jobs –
waiting

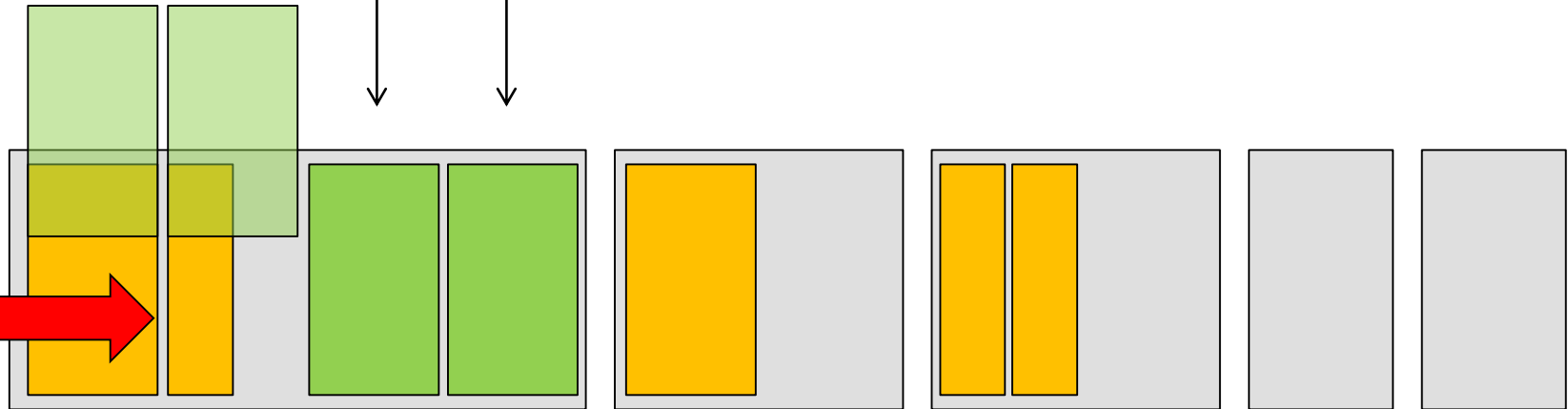

Chunks arrangement

- free vs. pack vs. scatter

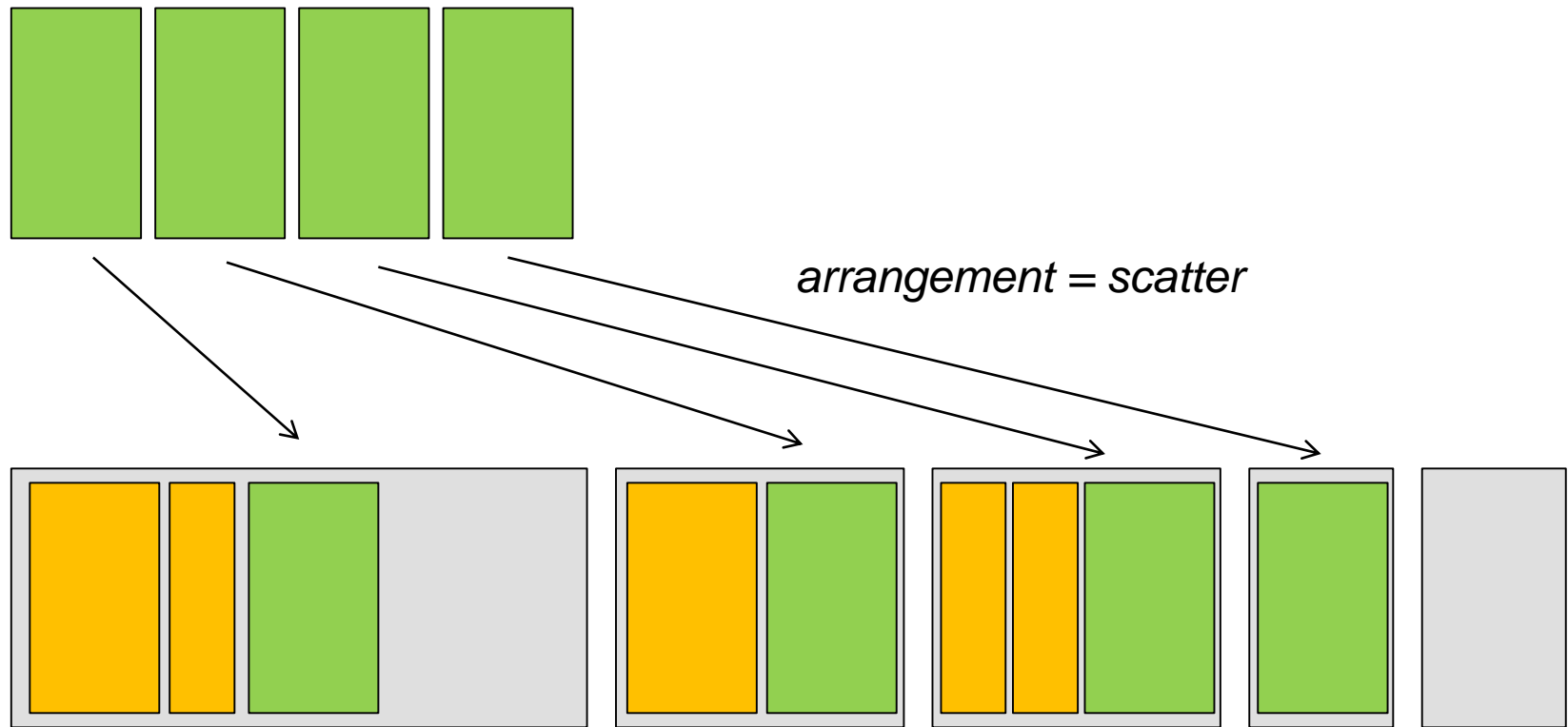

How to ... specify requested resources IX.

Questions and Answers:

- *Why is it necessary to specify the resources in a proper number/amount?*
 - because when a job consumes more resources than announced, it will be **killed** by us (you'll be informed)
 - otherwise it may influence other processes running on the node
- *Why is it necessary not to ask for excessive number/amount of resources?*
 - the jobs having smaller resource requirements are started (i.e., get the time slot) **faster**
- *Any other questions?*



How to ... specify requested resources IX.

Questions and Answers:

- *Why is it necessary to specify the resources in a proper number/amount?*
 - because when a job consumes more resources than announced, it will be **killed** by us (you'll be informed)
 - otherwise it may influence other processes running on the node
- *Why is it necessary not to ask for excessive number/amount of resources?*
 - the jobs having smaller resource requirements are started

See more details about PBSpro scheduler:

■ <https://metavo.metacentrum.cz/cs/seminars/seminar2017/presentation-Klusacek.pptx>

SHORT guide:

<https://metavo.metacentrum.cz/export/sites/meta/cs/seminars/seminar2017/tahak-pbs-pro-small.pdf>

Overview

- Introduction
 - MetaCentrum / CERIT-SC infrastructure overview
 - How to ... specify requested resources
 - **How to ... run an interactive job**
 - How to ... use application modules
 - How to ... run a batch job
 - How to ... determine a job state
 - Another mini-HowTos ...
 - What to do if something goes wrong?
-
- Real-world examples
 - Appendices

How to ... run an interactive job I.

Interactive jobs:

- result in getting a prompt on a single **(master) node**
 - one may perform interactive computations
 - the other nodes, if requested, remain allocated and accessible (see later)

- How to **ask for an interactive job?**
 - add the option “-I” to the qsub command
 - e.g., `qsub -I -l select=1:ncpus=4`

- **Example** (valid just for this demo session):
 - `qsub -I -q MetaSeminar # (-l select=1:ncpus=1)`

How to ... run an interactive job II.

Textual mode: simple

Graphical mode:

- *(preferred)* **remote desktops based on VNC servers (pilot run):**
- available from frontends as well as computing nodes (interactive jobs)
 - `module add gui`
 - `gui start [-s] [-g GEOMETRY] [-c COLORS]`
 - uses one-time passwords
 - allows to access the VNC via a supported **TigerVNC client**
 - **allows SSH tunnels** to be able to connect with a wide-range of clients
 - allows to specify several parameters (e.g., **desktop resolution, color depth**)
 - `gui info [-p] ...` displays active sessions (optionally with login password)
 - `gui traverse [-p] ...` display all the sessions throughout the infrastructure
 - `gui stop [sessionID] ...` allows to stop/kill an active session
- **see more info at**
https://wiki.metacentrum.cz/wiki/Remote_desktop

How to ... run an interactive job II.

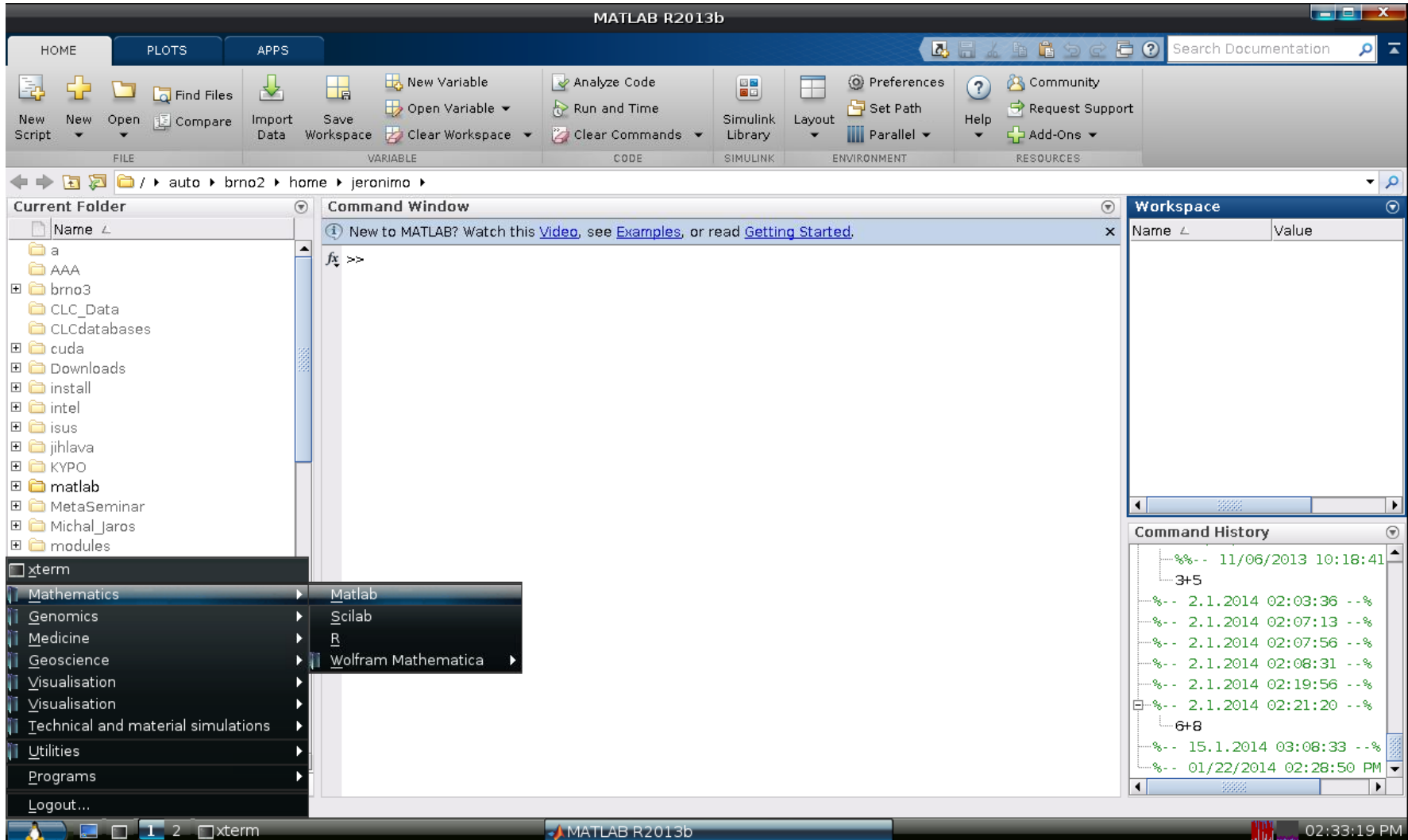

The image shows the MATLAB R2013b interface. The top menu bar includes HOME, PLOTS, and APPS. The ribbon contains various toolbars for file operations, workspace management, code execution, and environment settings. The current folder is set to / auto / brno2 / home / jeronimo. The Command Window shows a prompt >>. The Workspace panel is empty. The Command History panel shows a list of executed commands and their timestamps.

Command History

Command	Timestamp
3+5	11/06/2013 10:18:41
2.1.2014 02:03:36 --%	2.1.2014 02:03:36 --%
2.1.2014 02:07:13 --%	2.1.2014 02:07:13 --%
2.1.2014 02:07:56 --%	2.1.2014 02:07:56 --%
2.1.2014 02:08:31 --%	2.1.2014 02:08:31 --%
2.1.2014 02:19:56 --%	2.1.2014 02:19:56 --%
2.1.2014 02:21:20 --%	2.1.2014 02:21:20 --%
6+8	15.1.2014 03:08:33 --%
01/22/2014 02:28:50 PM	01/22/2014 02:28:50 PM

How to ... run an interactive job II.

Graphical mode (further options):

- *(fallback)* tunnelling a display through `ssh` (Windows/Linux):
 - connect to the frontend node having SSH forwarding/tunneling enabled:
 - Linux: `ssh -X skirit.metacentrum.cz`
 - Windows:
 - install an XServer (e.g., Xming)
 - set Putty appropriately to enable X11 forwarding when connecting to the frontend node
 - Connection → SSH → X11 → Enable X11 forwarding
 - ask for an interactive job, **adding “-x” option** to the `qsub` command
 - e.g., `qsub -I -x -l select=... ..`
- *(tech. gurus)* **exporting a display** from the master node to a Linux box:
 - `export DISPLAY=mycomputer.mydomain.cz:0.0`
 - on a Linux box, run `xhost +` to allow all the remote clients to connect
 - be sure that your display manager allows remote connections

How to ... run an interactive job III.

Questions and Answers:

- *How to **get an information** about the **other nodes/chunks allocated** (if requested)?*
 - `master_node$ cat $PBS_NODEFILE`
 - works for batch jobs as well
- *How to **use the other nodes/chunks**? (holds for batch jobs as well)*
 - MPI jobs use them automatically
 - otherwise, use the **pbsdsh** utility (see "man pbsdsh" for details) to run a remote command
 - if the pbsdsh does not work for you, use the **ssh** to run the remote command
- *Any other questions?*



How to ... run an interactive job III.

Questions and Answers:

- *How to **get an information** about the **other nodes/chunks allocated***

Hint:

- there are several useful environment variables one may use
 - `$ set | grep PBS`
- e.g.:
 - PBS_JOBID ... job's identifier
 - PBS_NUM_NODES, PBS_NUM_PPN ... allocated number of nodes/processors
 - PBS_O_WORKDIR ... submit directory
 - ...

un a



Overview

- Introduction
 - MetaCentrum / CERIT-SC infrastructure overview
 - How to ... specify requested resources
 - How to ... run an interactive job
 - **How to ... use application modules**
 - How to ... run a batch job
 - How to ... determine a job state
 - Another mini-HowTos ...
 - What to do if something goes wrong?
-
- Real-world examples
 - Appendices

How to ... use application modules I.

Application modules:

- the **modullar subsystem** provides a user interface to modifications of user environment, which are necessary for running the requested applications
- allows to “add” an application to a user environment
- **getting a list** of available application modules:
 - `$ module avail`
 - `$ module avail matl`
 - <https://wiki.metacentrum.cz/wiki/Kategorie:Applications>
 - provides the documentation about modules' usage
 - besides others, includes:
 - information whether it is necessary to ask the scheduler for an available licence
 - information whether it is necessary to express consent with their licence agreement

How to ... use application modules II.

Application modules:

- **loading** an application into the environment:
 - `$ module add <modulename>`
 - e.g., `module add maple`
- **listing** the already loaded modules:
 - `$ module list`
- **unloading** an application from the environment:
 - `$ module del <modulename>`
 - e.g., `module del openmpi`
- **Note:** *An application may require to express consent with its licence agreement before it may be used (see the application's description). To provide the agreement, visit the following webpage: <https://metavo.metacentrum.cz/cs/myaccount/licence.html>*
- for more information about application modules, see https://wiki.metacentrum.cz/wiki/Application_modules

Overview

- Introduction
 - MetaCentrum / CERIT-SC infrastructure overview
 - How to ... specify requested resources
 - How to ... run an interactive job
 - How to ... use application modules
 - **How to ... run a batch job**
 - How to ... determine a job state
 - Another mini-HowTos ...
 - What to do if something goes wrong?
-
- Real-world examples
 - Appendices

Preparation before batch demos

Copy-out the pre-prepared demos:

```
$ cp -rH /storage/brno2/home/jeronimo/MetaSeminar/latest $HOME
```

Text editors in Linux:

- *experienced users:* `vim <filename>`
 - very flexible, feature-rich, great editor...
- *common users:* `mcedit <filename>`



Preparation before batch demos

Copy-out the pre-prepared demos:

```
$ cp -rH /storage/brno2/home/jeronimo/MetaSeminar/latest $HOME
```

Text editors in Linux:

- *experienced users:* `vim <filename>`
 - very flexible, feature-rich, great editor...

- *common users:* `mcedit <filename>`
 - *easy to remember alternative:* `pico <filename>` ☺



How to ... run a batch job I.

Batch jobs:

- perform the computation as described in their **startup script**
 - the submission results in getting a **job identifier**, which further serves for getting more information about the job (see later)

- How to **submit a batch job**?
 - add the reference to the startup script to the qsub command
 - e.g., `qsub -l select=3:ncpus=4 <myscript.sh>`

- **Example** (valid for this demo session):
 - `qsub -q MetaSeminar -l select=1:ncpus=1 myscript.sh`
 - results in getting something like `"12345.arien-pro.ics.muni.cz"`

How to ... run a batch job I.

B

Hint:

- create the file `myscript.sh` with the following content:

- `$ vim myscript.sh`

```
#!/bin/bash
```

```
# my first batch job
```

```
uname -a
```

- see the standard output file (`myscript.sh.o<JOBID>`)

- `$ cat myscript.sh.o<JOBID>`

for

- ❑ `qsub -q MetaSeminar -l select=1:ncpus=1 myscript.sh`
- ❑ results in getting something like `"12345.arien-pro.ics.muni.cz"`

How to ... run a batch job II.

Startup script skelet: (non IO-intensive computations)

- use just when you know, what you are doing...

```
#!/bin/bash
```

```
DATADIR="/storage/brno2/home/$USER/" # shared via NFSv4  
cd $DATADIR
```

```
# ... load modules & perform the computation ...
```

- **further details** – see

https://wiki.metacentrum.cz/wiki/How_to_compute/Requesting_resources

How to ... run a batch job III.

Recommended startup script skelet: (IO-intensive computations or long-term jobs)

```
#!/bin/bash

# set a handler to clean the SCRATCHDIR once finished
trap 'clean_scratch' TERM EXIT
# if temporal results are important/useful
# trap 'cp -r $SCRATCHDIR/neuplna.data $DATADIR && clean_scratch' TERM

# set the location of input/output data
# DATADIR="/storage/brno2/home/$USER/"
DATADIR="$PBS_O_WORKDIR"

# prepare the input data
cp $DATADIR/input.txt $SCRATCHDIR

# go to the working directory and perform the computation
cd $SCRATCHDIR

# ... load modules & perform the computation ...

# copy out the output data
# if the copying fails, let the data in SCRATCHDIR and inform the user
cp $SCRATCHDIR/output.txt $DATADIR || export CLEAN_SCRATCH=false
```

How to ... run a batch job IV.

Using the application modules within the batch script:

- `module add SW`
 - e.g., „`module add maple`“
- include the initialization line (“`source ..`”) if necessary:
 - i.e., if you experience problems like “`module: command not found`”, then add `source /software/modules/init` before „*module add*“ sections

Getting the job’s standard output and standard error output:

- once finished, there appear **two files** in the directory, which the job has been started from:
 - `<job_name>.o<jobID> ...` standard output
 - `<job_name>.e<jobID> ...` standard error output
 - the `<job_name>` can be modified via the “`-N`” `qsub` option

How to ... run a batch job V.

Job attributes specification:

in the case of batch jobs, the requested resources and further job information (*job attributes* in short) may be specified either on the command line (see “man qsub”) or directly within the script:

- by adding the “#PBS” directives (see “man qsub”):

```
#PBS -N Job_name
```

```
#PBS -l select=2:ncpus=1:mem=320kb:scratch_local=100m
```

```
#PBS -m abe
```

```
#
```

```
< ... commands ... >
```

- the submission may be then simply performed by:

```
❑ $ qsub myscript.sh
```

- if options are provided both in the script and on the command-line, the **command-line arguments override the script ones**

How to ... run a batch job VI. (complex example)

```
#!/bin/bash
#PBS -l select=1:ncpus=2:mem=500mb:scratch_local=100m
#PBS -m abe

# set a handler to clean the SCRATCHDIR once finished
trap "clean_scratch" TERM EXIT

# set the location of input/output data
DATADIR="$PBS_O_WORKDIR"

# prepare the input data
cp $DATADIR/input.mpl $SCRATCHDIR

# go to the working directory and perform the computation
cd $SCRATCHDIR

# load the appropriate module
module add maple

# run the computation
maple input.mpl

# copy out the output data (if it fails, let the data in SCRATCHDIR and inform the user)
cp $SCRATCHDIR/output.gif $DATADIR || export CLEAN_SCRATCH=false
```

How to ... run a batch job VII.

Questions and Answers:

- *Should you prefer batch or interactive jobs?*
 - definitely the **batch ones** – they use the computing resources **more effectively**
 - use the interactive ones just for testing your startup script, GUI apps, or data preparation

- *Any other questions?*



How to ... run a batch job VIII.

Example:

- Create and submit a batch script, which performs a simple Maple computation, described in a file:

```
plotsetup(gif, plotoutput=`myplot.gif`,  
          plotoptions=`height=1024,width=768`);  
plot3d( x*y, x=-1..1, y=-1..1, axes = BOXED, style =  
        PATCH);
```

- process the file using Maple (from a batch script):
 - hint: `$ maple <filename>`

How to ... run a batch job VIII.

Example:

- Create and submit a batch script, which performs a simple Maple computation, described in a file:

```
plotsetup(gif, plotoutput=`myplot.gif`,  
          plotoptions=`height=1024,width=768`);  
plot3d( x*y, x=-1..1, y=-1..1, axes = BOXED, style =  
        PATCH);
```

- process the file using Maple (from a batch script):
 - hint: `$ maple <filename>`

Hint:

- see the solution at
`/storage/brno2/home/jeronimo/MetaSeminar/latest/Maple`

Overview

- Introduction
 - MetaCentrum / CERIT-SC infrastructure overview
 - How to ... specify requested resources
 - How to ... run an interactive job
 - How to ... use application modules
 - How to ... run a batch job
 - **How to ... determine a job state**
 - Another mini-HowTos ...
 - What to do if something goes wrong?
-
- Real-world examples
 - Appendices

How to ... determine a job state I.

Job identifiers

- every job (no matter whether interactive or batch) is **uniquely identified** by its identifier (JOBID)
 - e.g., 12345.arien-pro.ics.muni.cz
- to obtain any information about a job, the **knowledge of its identifier is necessary**
 - how to list all the recent jobs?
 - graphical way – PBSMON: <http://metavo.metacentrum.cz/pbsmon2/jobs/allJobs>
 - frontend\$ qstat (run on any frontend)
 - **to include finished ones, run \$ qstat -x**
 - how to list all the recent jobs of a specific user?
 - graphical way – PBSMON: <https://metavo.metacentrum.cz/pbsmon2/jobs/my>
 - frontend\$ qstat -u <username> (again, any frontend)
 - **to include finished ones, run \$ qstat -x -u <username>**

How to ... determine a job state II.

How to determine a job state?

- graphical way – see PBSMON
 - list all your jobs and click on the particular job's identifier
 - <http://metavo.metacentrum.cz/pbsmon2/jobs/my>
- textual way – `qstat` command (see `man qstat`)
 - brief information about a job: `$ qstat JOBID`
 - informs about: job's state (*Q=queued, R=running, E=exiting, F=finished, ...*), job's runtime, ...
 - complex information about a job: `$ qstat -f JOBID`
 - shows all the available information about a job
 - useful properties:
 - `exec_host` -- the nodes, where the job did really run
 - `resources_used`, `start/completion time`, `exit status`, ...
 - necessary to add „-x“ **option** when examining already finished job(s)

How to ... determine a job state III.

Hell, when my jobs will really start?

- nobody can tell you 😊
 - the **God/scheduler decides** (based on the other job's finish)
 - we're working on an estimation method to inform you about its probable startup

- check the **queues' fulfilment**:
<http://metavo.metacentrum.cz/cs/state/jobsQueued>
 - the higher fairshare (queue's AND job's) is, the earlier the job will be started
- **stay informed** about job's startup / finish / abort (via email)
 - by default, just an information about job's abortation is sent
 - → when submitting a job, add “-m abe” option to the `qsub` command to be informed about all the job's states
 - or “#PBS -m abe” directive to the startup script

How to ... determine a job state IV.

Monitoring running job's stdout, stderr, working/temporal files

1. via ssh, log in directly to the execution node(s)
 - how to get the job's execution node(s)?
 - to examine the working/temporal files, navigate directly to them
 - logging to the execution node(s) is necessary -- even though the files are on a shared storage, their content propagation takes some time
 - to examine the stdout/stderr of a running job:
 - navigate to the `/var/spool/pbs/spool/` directory and examine the files:
 - `$PBS_JOBID.OU` for standard output (stdout – e.g., “1234.arien-pro.ics.muni.cz.OU”)
 - `$PBS_JOBID.ER` for standard error output (stderr – e.g., “1234.arien-pro.ics.muni.cz.ER”)

Job's forcible termination

- `$ qdel JOBID` (the job may be terminated in any previous state)
- during termination, the job turns to *E (exiting)* and finally to *F (finished)* state

Overview

- Introduction
- MetaCentrum / CERIT-SC infrastructure overview
- How to ... specify requested resources
- How to ... run an interactive job
- How to ... use application modules
- How to ... run a batch job
- How to ... determine a job state
- **Another mini-HowTos ...**
- What to do if something goes wrong?

- Real-world examples
- Appendices

Another mini-HowTos ...

- **how to use privileged resources?**
 - if your institution/project integrates HW resources, a defined group of users may have priority access to them
 - technically accomplished using scheduler queues
 - a job has to be **submitted to the particular queue**
 - `qsub -l select=... -l walltime=... -q PRIORITY_QUEUE script.sh`
 - e.g., ELIXIR CZ project integrates a set of resources
 - priority queue „elixir_2w“ available for ELIXIR CZ users
 - moving jobs between scheduler queues
 - from priority queue **to default queue**
 - `qmove default JOBID`
 - from default queue(s) **to a priority queue**
 - `qmove elixir_2w JOBID`

Another mini-HowTos ...

- **how to make your SW tool available within MetaVO?**
 - *commercial apps:*
 - **assumption:** you own a license, and the license allows the application to be run on our infrastructure (nodes not owned by you, located elsewhere, etc.)
 - once installed, we can **restrict its usage** just for you (or for your group)
 - *open-source/freeware apps:*
 - you can compile/install the app in your HOME directory
 - **OR** you can install/compile the app on your own and ask us to make it available in the software repository
 - compile the application in your HOME directory
 - **prepare a modulefile** setting the application environment
 - inspire yourself by modules located at `/packages/run/modules-2.0/modulefiles`
 - **test the app/modulefile**
 - `$ export MODULEPATH=$MODULEPATH:$HOME/myapps`
 - see https://wiki.metacentrum.cz/wiki/How_to_install_an_application
 - **OR you can ask us for preparing the application for you**

Another mini-HowTos ...

- **how to ask for nodes equipped by GPU cards?**
 - determine, **how many GPUs** your application will need (`-l ngpus=X`)
 - consult the HW information page: <http://metavo.metacentrum.cz/cs/state/hardware.html>
 - determine, **how long** the application will run (if you need more, let us know)
 - `gpu_queue` ... maximum runtime 1 day
 - `gpu_long_queue` ... maximum runtime 1 week
 - make the submission:
 - `$ qsub -l select=1:ncpus=4:mem=10g:ngpus=1 -q gpu_long -l walltime=4d ...`
 - specific GPU cards by restricting the cluster:
`qsub -l select=...:cl_doom=true ...`
 - **do not change** the `CUDA_VISIBLE_DEVICES` environment variable
 - it's automatically set in order to determine the GPU card(s) that has/have been reserved for your application
 - details about GPU cards performance within MetaVO:
 - see http://metavo.metacentrum.cz/export/sites/meta/cs/seminars/seminar5/gpu_fila.pdf
 - general information: https://wiki.metacentrum.cz/wiki/GPU_clusters

Another mini-HowTos ...

How to ask for nodes equipped with Xeon Phi?

phi[1-6].cerit-sc.cz

- new cluster purchased by CERIT-SC
 - available through “phi” queue (PBS Pro) on zuphux.cerit-sc.cz frontend

```
zuphux$ qsub -q phi -l select=...
```
- **the newest generation of Xeon Phi** (7210 Knights Landing)
 - currently, the only installation in the CR
- see more details at
<https://metavo.metacentrum.cz/export/sites/meta/cs/seminars/seminar2017/meta-xeonphi-17.pdf>

Installation specifics:

- **/storage/brno3-cerit** is the only central storage **directly mounted**
 - all the rest storages available through SCP only

Central storages of phi.cerit-sc.cz cluster

Central storages not available through NFS

i.e. `/storage/XXX/home/<username>`

- technical reasons
- data storages available through SCP
 - besides brno3-cerit, which is mounted directly
 - in most cases, just a minor change in your scripts

NFS sharing (most clusters)

```
DATADIR="/storage/brno2/home/<username>/example"
```

```
cp -R $DATADIR/mydata $SCRATCHDIR
```

SCP sharing (phi[1-6].cerit-sc.cz)

```
DATADIR="storage-brno2.metacentrum.cz:~/example"
```

```
scp -R $DATADIR/mydata $SCRATCHDIR
```

Another mini-HowTos ...

- **how to transfer large amount of data to computing nodes?**
 - copying through the frontends/computing nodes may not be efficient (hostnames are *storage-XXX.metacentrum.cz*)
 - XXX = brno2, brno3-cerit, plzen1, budejovice1, praha1, ...
 - → connect directly to the storage frontends (via **SCP** or **SFTP**)
 - `$ sftp storage-brno2.metacentrum.cz`
 - `$ scp <files> storage-plzen1.metacentrum.cz:<dir>`
 - etc.
 - use FTP only together with the Kerberos authentication
 - otherwise insecure

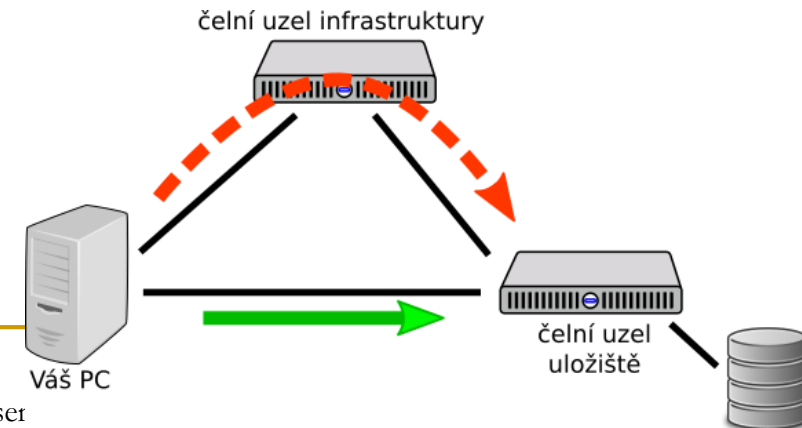

Another mini-HowTos ...

- **how to get information about your quotas?**
 - by default, all the users have quotas on the storage arrays (per array)
 - may be different on every array
 - to get an information about your quotas and/or free space on the storage arrays
 - **textual way:** log-in to a MetaCentrum frontend and see the “*motd*” (information displayed when logged-in)
 - **graphical way:**
 - *your quotas:* <https://metavo.metacentrum.cz/cs/myaccount/kvoty>
 - *free space:* <http://metavo.metacentrum.cz/pbsmon2/nodes/physical>
- **how to restore accidentally erased data**
 - the storage arrays (⇒ including homes) are regularly backed-up
 - several times a week
 - → write an email to meta@cesnet.cz specifying what to restore

Another mini-HowTos ...

- **how to secure private data?**
 - by default, all the data are readable by everyone
 - → use **common Linux/Unix mechanisms/tools** to make the data private
 - `r,w,x` rights for *user, group, other*
 - e.g., `chmod go= <filename>`
 - see `man chmod`
 - use “-R” option for recursive traversal (applicable to directories)

- **how to share data among working group?**
 - ask us for creating a **common unix user group**
 - user administration will be up to you (GUI frontend is provided)
 - **use common unix mechanisms** for sharing data among a group
 - see “`man chmod`” and “`man chgrp`”
 - see https://wiki.metacentrum.cz/wikiold/Sdílení_dat_ve_skupině

Another mini-HowTos ...

- **how to use SGI UV2000 nodes? (ungu,urga .cerit-sc.cz)**
 - because of their nature, these nodes **are not** – by default – **used by common jobs**
 - to be available for jobs that really need them
 - to use these nodes, one has to **submit the job to a specific queue called “uv”**
 - `$ qsub -l select=1:ncpus=X:mem=Yg -q uv`
`-l walltime=Zd ...`
 - to use a specific UV node, submit e.g. with
`$ qsub -q uv -l select=1:ncpus=X:cl_urga=true ...`
 - for convenience, **submit from zuphux.cerit-sc.cz frontend**

Another mini-HowTos ...

- **how to run a set of (managed) jobs?**
 - some computations consist of a set of (managed) sub-computations
 - optional cases:
 - the computing workflow **is known when submitting**
 - specify dependencies among jobs
 - qsub's "**-w**" option (`man qsub`)
 - in case of many parallel subjobs, use „job arrays“ (qsub's „**-J**“ option)
 - the computing workflow **depends on result(s) of subcomputations**
 - run a master job, which analyzes results of subjobs and submits new ones
 - the master job should be submitted to a node dedicated for low-performance (controlling/re-submitting) tasks
 - available through the „oven“ queue
 - `qsub -q oven -l select=1:ncpus=... control_script.sh`

Overview

- Introduction
- MetaCentrum / CERIT-SC infrastructure overview
- How to ... specify requested resources
- How to ... run an interactive job
- How to ... use application modules
- How to ... run a batch job
- How to ... determine a job state
- Another mini-HowTos ...
- **What to do if something goes wrong?**

- Real-world examples
- Appendices

What to do if something goes wrong?

1. check the MetaVO/CERIT-SC documentation, application module documentation
 - whether you use the things correctly
2. check, whether there haven't been any infrastructure updates performed
 - visit the webpage <http://metavo.metacentrum.cz/cs/news/news.jsp>
 - one may stay informed via an RSS feed
3. write an email to meta@cesnet.cz, resp. support@cerit-sc.cz
 - your email will create a ticket in our Request Tracking system
 - identified by a unique number → one can easily monitor the problem solving process
 - please, include **as good problem description as possible**
 - problematic job's JOBID, startup script, problem symptoms, etc.

Overview

- Introduction
- MetaCentrum / CERIT-SC infrastructure overview
- How to ... specify requested resources
- How to ... run an interactive job
- How to ... use application modules
- How to ... run a batch job
- How to ... determine a job state
- Another mini-HowTos ...
- What to do if something goes wrong?

- **Real-world examples**
- Appendices

Real-world examples

Examples:

- Maple
- Gaussian + Gaussian Linda
- Gromacs (CPU + GPU)
- Matlab (parallel & GPU)
- Ansys CFX
- OpenFoam
- Echo
- R – Rmpi

■ demo sources:

```
/storage/brno2/home/jeronimo/MetaSeminar/latest
```

command: `cp -rH /storage/brno2/home/jeronimo/MetaSeminar/latest $HOME`



Projekt CERIT Scientific Cloud (reg. no. CZ.1.05/3.2.00/08.0144) byl podporován operačním programem *Výzkum a vývoj pro inovace*, 3 prioritní osy, podoblasti 2.3 *Informační infrastruktura pro výzkum a vývoj*.

www.cesnet.cz

www.metacentrum.cz

www.cerit-sc.cz

Overview

- Introduction
 - MetaCentrum / CERIT-SC infrastructure overview
 - How to ... specify requested resources
 - How to ... run an interactive job
 - How to ... use application modules
 - How to ... run a batch job
 - How to ... determine a job state
 - Another mini-HowTos ...
 - What to do if something goes wrong?
-
- Real-world examples
 - **Appendices**

Appendices

- **Common mistakes in computations**
- **How to deal with parallel/distributed computations?**
- **Other computing possibilities**
 - MetaCloud
 - Hadoop (MapReduce)
 - Specialized frontends – Galaxy, Chipster, ...

Common mistakes in computations

Common mistakes in computations

Feel free to use the infrastructure – if something crashes, it's our fault. ☺

Big data transfers

Do not copy higher amounts of data through frontends

- slower transfer
- frontends load

Big data transfers

Do not copy higher amounts of data through frontends

- slower transfer
- frontends load

Data could be copied directly through storage frontends

- SCP, WinSCP

`/storage/brno2 -> storage-brno2.metacentrum.cz`

`/storage/brno3-cerit -> storage-brno3-cerit.metacentrum.cz`

...

- https://wiki.metacentrum.cz/wiki/Working_with_data/Direct_access_to_data_storages

Big data transfers

Do not copy higher amounts of data through frontends

- slower transfer
- frontends load

Data could be copied directly through storage frontends

- SCP, WinSCP

`/storage/brno2 -> storage-brno2.metacentrum.cz`

`/storage/brno3-cerit -> storage-brno3-cerit.metacentrum.cz`

...

- https://wiki.metacentrum.cz/wiki/Working_with_data/Direct_access_to_data_storages

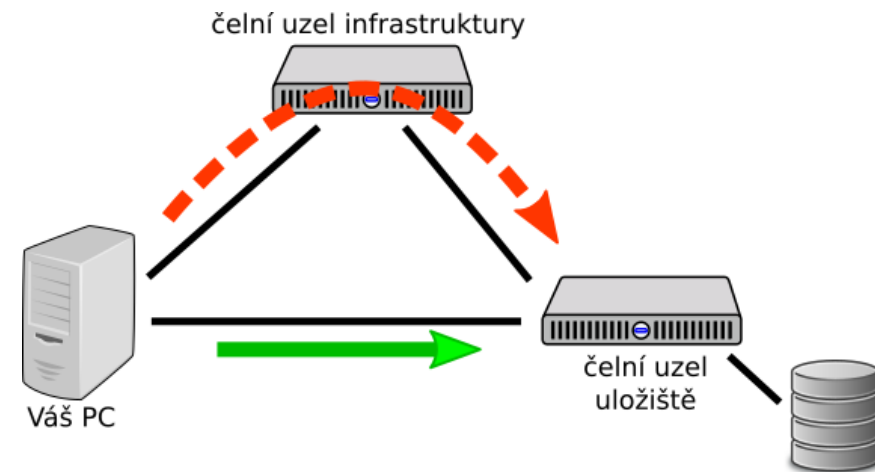

Computations and central storages

Do not run computations that compute over data located at central storages

- especially the I/O-intensive ones
 - increases central storage load and makes the computation slower

Compute over local copies in scratch directories

- *benefits:*
 - faster computations
 - computations do not rely on the availability of the central storage
- usage:
 - `$ qsub -l select=1:ncpus=4:scratch_local=1gb ...`
`cp /storage/.../home/<username>/mydata $SCRATCHDIR/mydata`
`cd $SCRATCHDIR`
`<compute>`
`cp $SCRATCHDIR/results /storage/.../home/<username>/results`
 - `...:scratch_shared=Xgb ... shared scratch (distributed computations)`
 - `...:scratch_ssd=Xgb ... local scratch – SSD disks`

Data in scratches

Clean the scratches once computations finish

- scratch data could be seen similarly as data in RAM memory
 - once a computation finishes, the data should be cleaned
- scratches are automatically cleaned by us
 - usually after 2 weeks a computation finishes

Clean scratch after your computations

- „clean_scratch” utility
- usage (in script file):

```
trap 'clean_scratch' TERM EXIT
...
cp results /storage/... || export CLEAN_SCRATCH=false
```

 - if the central storage is not available (the results could not be copied out), the data will remain in the particular scratch directory
 - user is informed about (non-)useful scratch cleanup
 - user is informed about scratches not correctly cleaned after previous computations

Central storages overused

Central (working) storages are not infinitely large ☹

/storage/<CITY>

Clean/move currently unnecessary data

– *possibilities:*

- delete unnecessary data
- move actually unnecessary data to archival storages
see https://wiki.metacentrum.cz/wiki/Archival_data_handling

Huge jobs' outputs and data in /tmp

Computing nodes restrict the amount of data a user is able to store to local disks (outside the scratch space) = 1 GB quota

- influences the /tmp directory (temporal files)
- influences the huge job's outputs (stdout, stderr)

Store bigger amounts of data to scratches

- forwarding the temporal directory
 - many applications follow the system variable TMPDIR
 - usage: `export TMPDIR=$SCRATCHDIR`
- forwarding the stdout/stderr of an application
 - `myapp ... 1>$SCRATCHDIR/stdout 2>$SCRATCHDIR/stderr`
- checking the status of your local quota and a list of files occupying it (once being informed by email)
 - utility `$ check-local-quota`
has to be run on the particular node (with exhausted local quota)

Non-effective computations

Be aware of the resource usage effectivity of your jobs

- a request for multiple CPUs/cores will not make a single-processor (single-thread) computation parallel (= it won't be faster)
 - just a single CPU will be used
- many applications significantly vary between the number of CPUs used throughout a computation
 - higher number of CPUs might be used just for a short time of the computation

Observing the computation usage of (not only) CPUs:

- *during a computation:*
 - log-in to the computation node (SSH) and use standard Linux tools (`top`, `htop`, ...)
- *after a computation:*
 - see the list of jobs at the MetaCentrum portal (<https://metavo.metacentrum.cz/cs/myaccount/myjobs.html>)
the non-effective jobs have red background color

Infiniband

Distributed jobs might run ineffectively because of slow communication channel

- the inter-process communication using standard network services (Ethernet) is slow
- **Infiniband** – specialized low-latency interconnect for fast inter-process communication in distributed computations

Most of our clusters are equipped with Infiniband

- considerably accelerates the performance of distributed (MPI) computations
 - the Infiniband availability is automatically detected
 - computations started always in the same way: `mpirun myapp`
 - if the Infiniband is not available, Ethernet is used as a fallback
- *request:*
 - `$ qsub -l select=... -l place=group=infiniband script.sh`

Many short-term jobs processing

Group/gather short-term jobs

- e.g., the ones running less than few minutes
 - startup overhead may be a significant part of the whole processing timeresults in wasting resources

Run more computations within a single job

- *possibilities:*
 - serial computations run inside a single job
 - process data1
 - process data2
 - ...
 - parallel computations run inside a single job (necessary to ask for enough CPUs)
 - pbsdsh
 - parallel

Computations on frontends

Do not run computations on frontends

- neither for computations nor for complex results analyses
 - increased frontend load results in limitation of its services (and usually frontend crash)
- frontend's primary job is jobs' preparation and very simple and short-term computations

Use interactive jobs

- *request:*
 - `$ qsub -I -l select=...`
- *usage possibilities:*
 - textual mode
 - graphical mode – VNC access
 - `$ module add gui`
 - `$ gui start`
 - see https://wiki.metacentrum.cz/wiki/Remote_desktop

Interactive jobs

Minimize the time lags in interactive jobs

- especially the time between job startup and your work (starting computations)
 - -> in the time lag, the resources are wasted

Stay informed about your job's startup

- *request:*
 - `$ qsub -m ab -I -l select=...`
will send you an email once the job begins
 - („-m abe” also in the case of job's finish)
- these options could be also used in batch jobs
but be aware of running too many jobs with this option set!
 - overloads your mailbox
 - may blacklist our mailservers at external mail providers ☺

Cloud nodes

Be aware about your VMs running

- even the unused VMs/nodes (but running) consume infrastructure resources
 - -> results in wasting resources, which somebody could use

Terminate/Suspend unused VMs

- we'll regularly inform you about your VMs running in case of no response (= time extension), the VMs are terminated

How to deal with parallel/distributed computations?

How to ... run a parallel/distributed computation I.

Parallel jobs (OpenMP):

- if your application is able to use multiple threads via a shared memory, **ask for a single node with multiple processors**

```
$ qsub -l select=1:ncpus=...
```

- **make sure**, that before running your application, the **OMP_NUM_THREADS** environment variable **is appropriately set**
 - otherwise, your application will use all the cores available on the node
 - → and influence other jobs...
 - usually, setting it to **NCPUs** is OK

```
$ export OMP_NUM_THREADS=$PBS_NUM_PPN
```

How to ... run a parallel/distributed computation II.

Distributed jobs (MPI):

- if your application consists of multiple processes communicating via a message passing interface, **ask for a set of nodes** (with arbitrary number of processors)

```
$ qsub -l select=...:ncpus=...
```

- **make sure**, that before running your application, the appropriate **openmpi/mpich2/mpich3/lam** module is loaded into the environment

```
$ module add openmpi
```

- then, you can use the `mpirun/mpiexec` routines

```
$ mpirun myMPIapp
```

- it's **not necessary** to provide these routines neither with the number of nodes to use ("`-np`" option) nor with the nodes itself ("`--hostfile`" option)
 - the computing nodes are **automatically detected** by the `openmpi/mpich/lam`

How to ... run a parallel/distributed computation III.

Distributed jobs (MPI): accelerating their speed I.

- to accelerate the speed of MPI computations, ask just for the nodes interconnected by a **low-latency Infiniband interconnection**
 - all the nodes of a cluster are interconnected by Infiniband
 - there are several clusters having an Infiniband interconnection
 - mandos, minos, hildor, skirit, tarkil, nympha, gram, luna, manwe (MetaCentrum)
 - zewura, zegox, zigur, zapat (CERIT-SC)

■ *submission example:*

```
$ qsub -l select=4:ncpus=2 -l place=group=infiniband MPIscript.sh
```

■ *starting an MPI computation using an Infiniband interconnection:*

- in a common way: `$ mpirun myMPIapp`
 - the Infiniband will be automatically detected
- is the Infiniband available for a job? **check using** `$ check-IB`

Chunks grouping

- ❑ accelerating distributed jobs
- ❑ -l place=group=infiniband

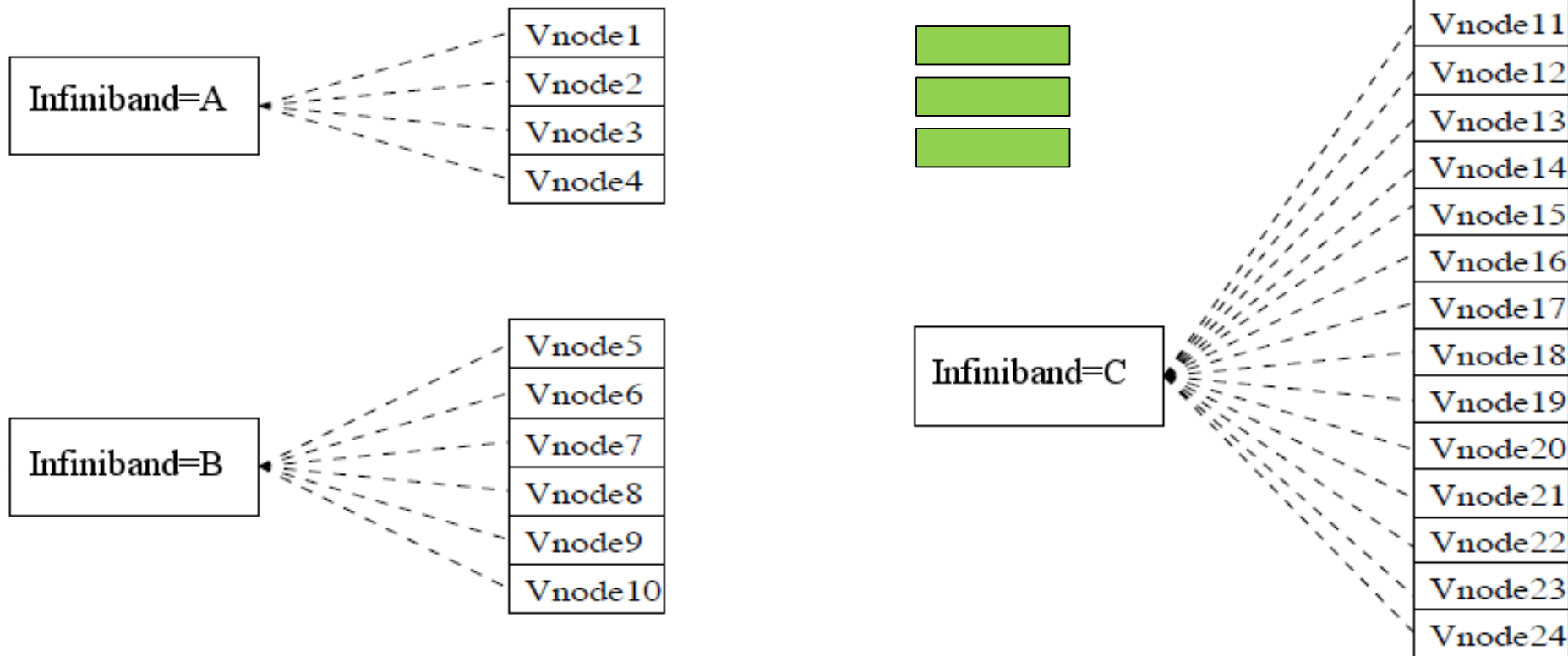

Chunks grouping

- accelerating distributed jobs
- -l place=group=infiniband

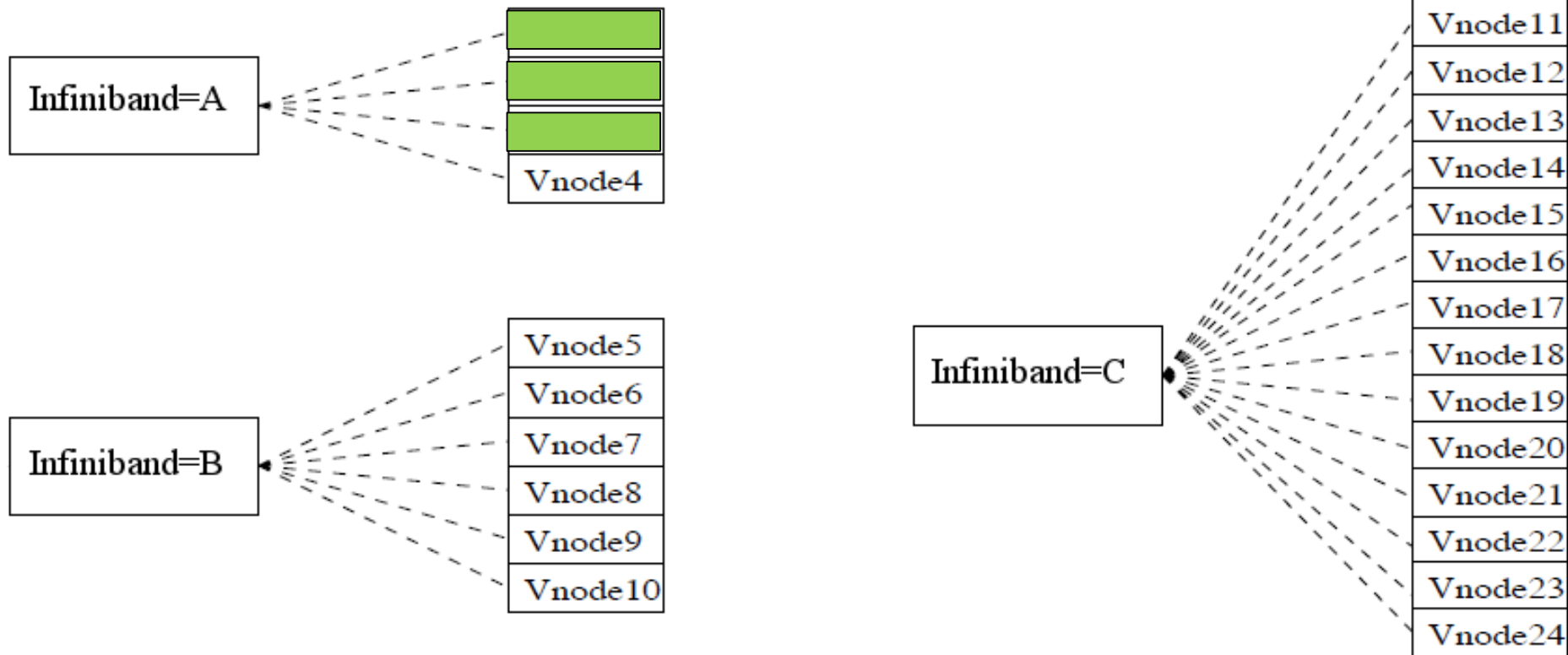

Chunks grouping

- ❑ accelerating distributed jobs
- ❑ -l place=group=infiniband

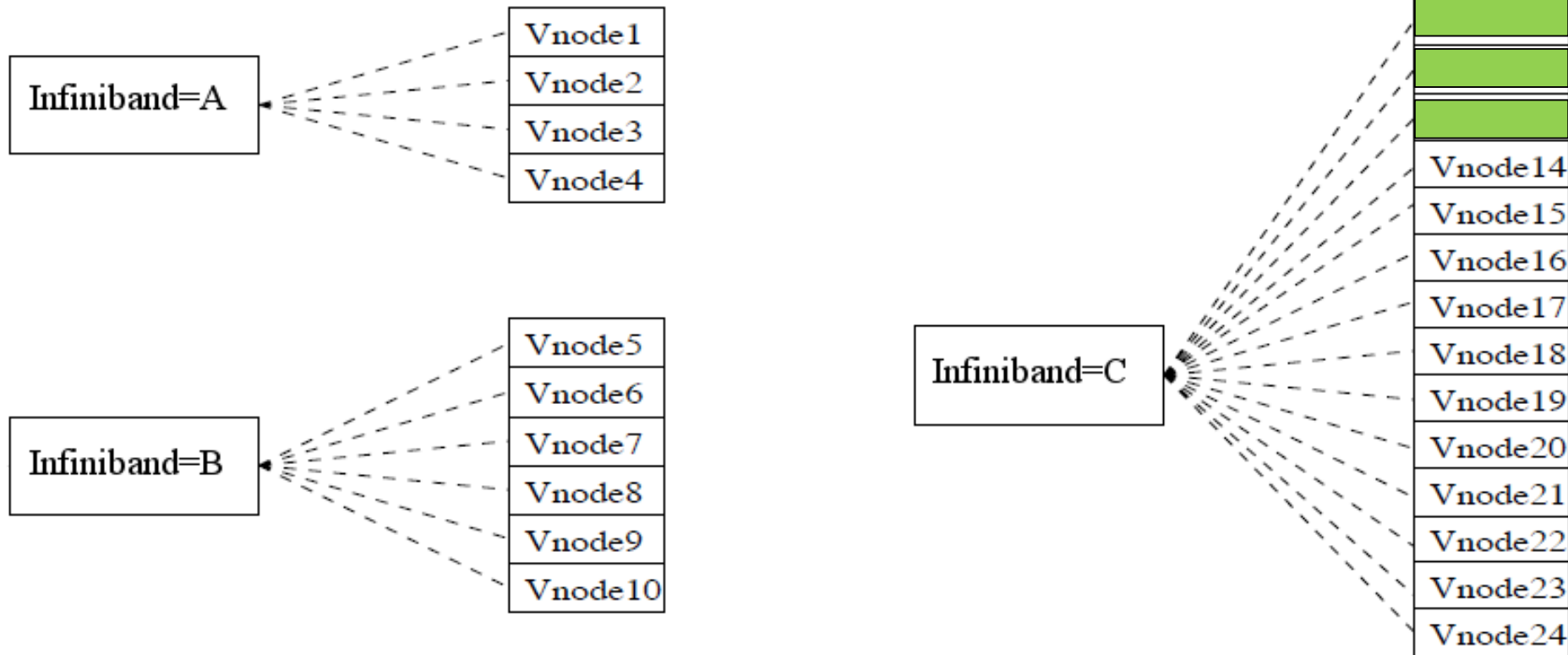

Chunks grouping

- ❑ accelerating distributed jobs
- ❑ -l place=group=infiniband

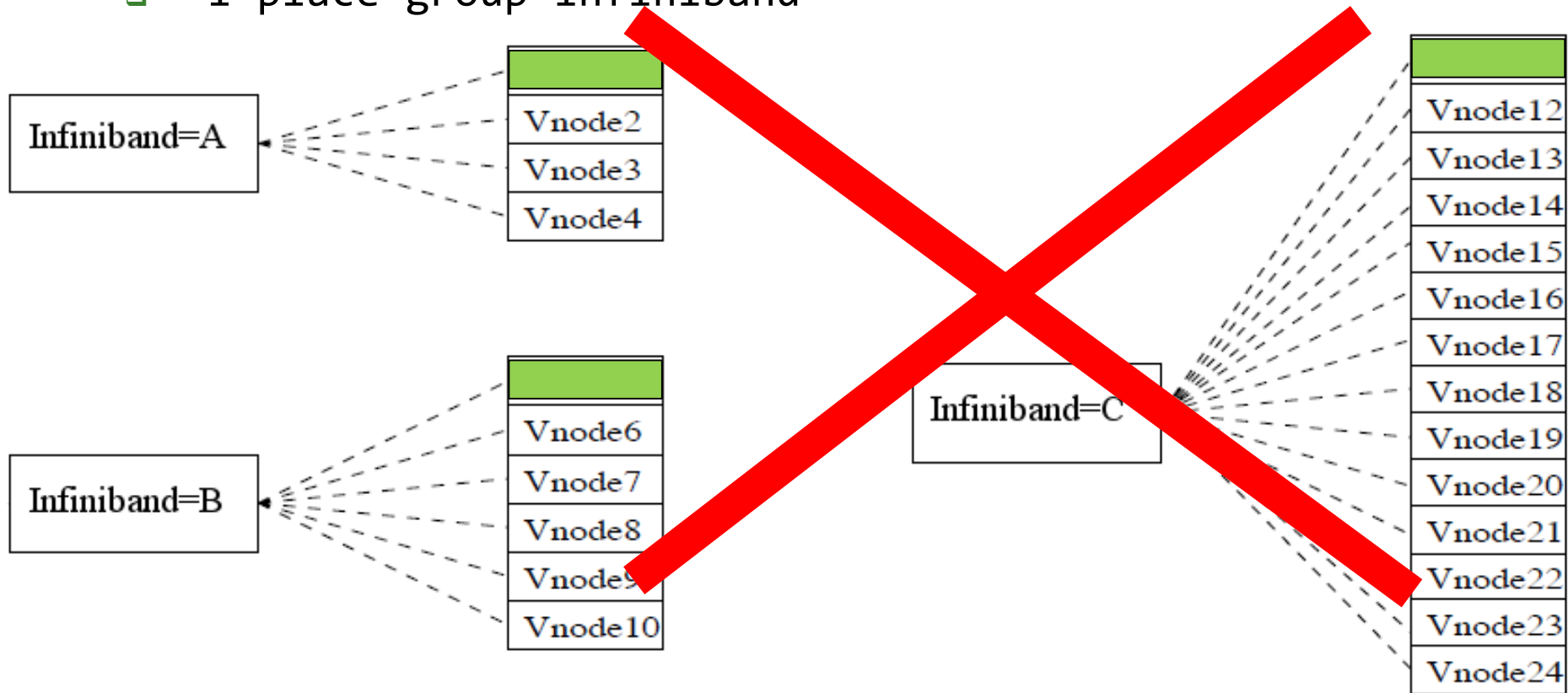

How to ... run a parallel/distributed computation IV.

Questions and Answers:

- *Is it possible to simultaneously use both OpenMP and MPI?*
 - Yes, it is. But be sure, how many processors your job is using
 - appropriately set the “-np” option (MPI) and the OMP_NUM_THREADS variable (OpenMP)
 - **OpenMPI:** a single process on each machine (`mpirun -pernode ...`) being threaded based on the number of processors (`export OMP_NUM_THREADS=$PBS_NUM_PPN`)

- Any other questions?



Other computing possibilities

Cloud computing – MetaCloud

Grid vs. Cloud computing

Grid computing suitable for:

- long-term and/or large-scale computations
 - (primarily batch processing)
- applications not requiring special OSs (features)
 - pre-installed or users' ones

Cloud computing suitable for:

- applications requiring special environment (OS) and/or features
 - one can run various operating systems (incl. Windows OS) and/or application equipment
 - administrator/root access is provided

Cloud computing

How to compute?

- **additional registration to MetaCloud** group required
 - your SSH key is needed to access the VMs
 - <https://perun.metacentrum.cz/fed/registrar/?vo=meta&group=metacloud>
- OpenNebula GUI for deployed nodes management
 - <https://cloud.metacentrum.cz/>
- interact via:
 - cloud/VM console
 - internal OS services (SSH, VNC, Rdesktop, ...)

Cloud computing

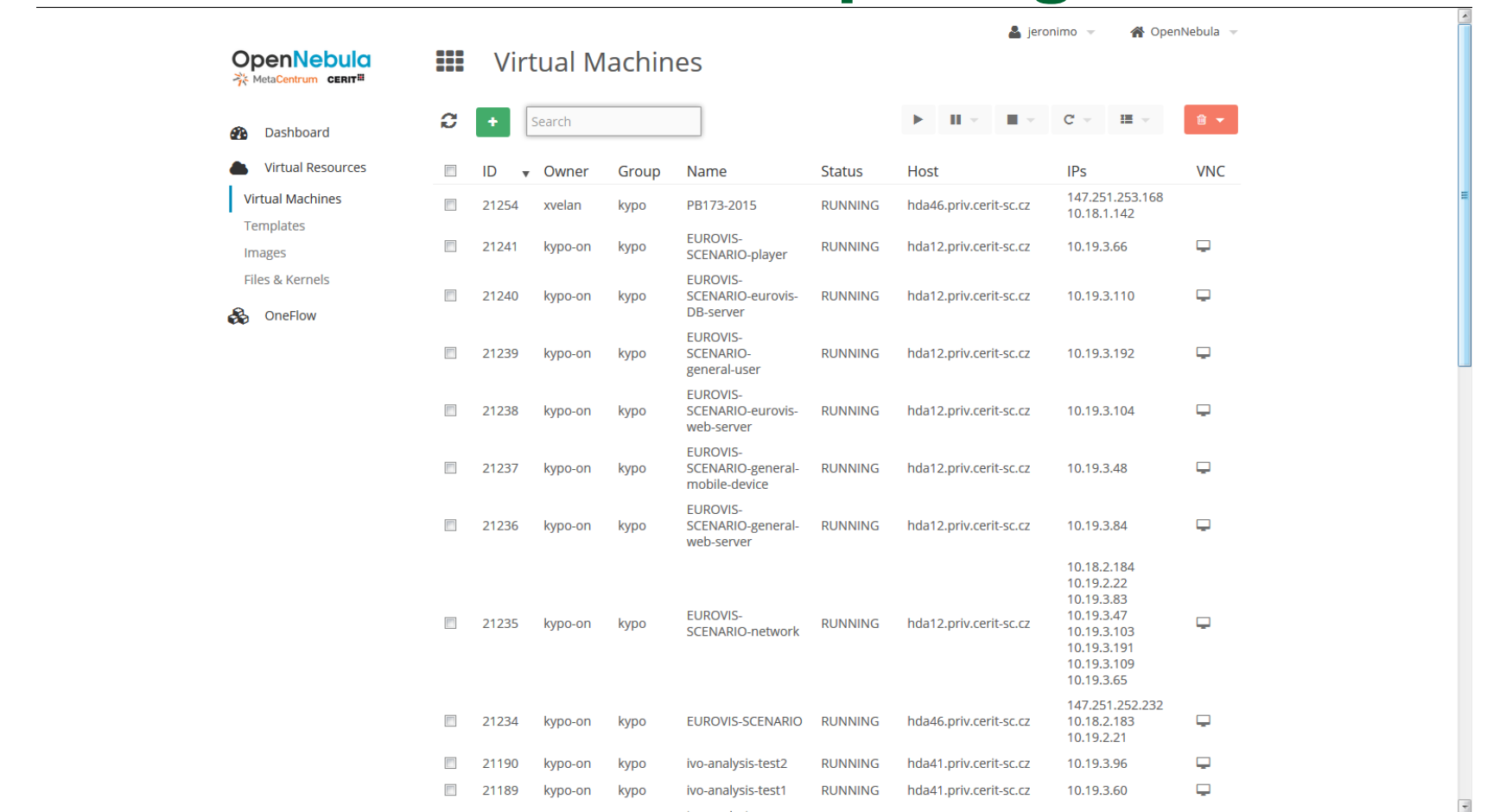

OpenNebula
MetaCentrum CERIT

Dashboard
Virtual Resources
Virtual Machines
Templates
Images
Files & Kernels
OneFlow

Virtual Machines

Search

ID	Owner	Group	Name	Status	Host	IPs	VNC
21254	xvelan	kypo	PB173-2015	RUNNING	hda46.priv.cerit-sc.cz	147.251.253.168 10.18.1.142	
21241	kypo-on	kypo	EUROVIS-SCENARIO-player	RUNNING	hda12.priv.cerit-sc.cz	10.19.3.66	
21240	kypo-on	kypo	EUROVIS-SCENARIO-eurovis-DB-server	RUNNING	hda12.priv.cerit-sc.cz	10.19.3.110	
21239	kypo-on	kypo	EUROVIS-SCENARIO-general-user	RUNNING	hda12.priv.cerit-sc.cz	10.19.3.192	
21238	kypo-on	kypo	EUROVIS-SCENARIO-eurovis-web-server	RUNNING	hda12.priv.cerit-sc.cz	10.19.3.104	
21237	kypo-on	kypo	EUROVIS-SCENARIO-general-mobile-device	RUNNING	hda12.priv.cerit-sc.cz	10.19.3.48	
21236	kypo-on	kypo	EUROVIS-SCENARIO-general-web-server	RUNNING	hda12.priv.cerit-sc.cz	10.19.3.84	
21235	kypo-on	kypo	EUROVIS-SCENARIO-network	RUNNING	hda12.priv.cerit-sc.cz	10.18.2.184 10.19.2.22 10.19.3.83 10.19.3.47 10.19.3.103 10.19.3.191 10.19.3.109 10.19.3.65	
21234	kypo-on	kypo	EUROVIS-SCENARIO	RUNNING	hda46.priv.cerit-sc.cz	147.251.252.232 10.18.2.183 10.19.2.21	
21190	kypo-on	kypo	ivo-analysis-test2	RUNNING	hda41.priv.cerit-sc.cz	10.19.3.96	
21189	kypo-on	kypo	ivo-analysis-test1	RUNNING	hda41.priv.cerit-sc.cz	10.19.3.60	

Basic terminology

- **template** – a description of the node („computer“) you are asking from the cloud
 - specifies requested CPUs, memory, disk storage, network interfaces, etc.
 - predefined ones & own ones
- **image** – a storage space („HDD“)
 - equipped with an OS or not
 - *persistent* & *non-persistent* (default; data are lost when destroying the VM)
- **network security group** – a set of firewall rules
 - restricts the access to the VM
- **instance** – a running node/computer created based on some template receipt
- **VM console** – a VNC connection to the VM („computer screen“)

Common usage

Common operations with MetaCloud:

- ❑ see [video tutorial](#)
- ❑ for advanced use, see MetaCloud documentation
 - e.g., creating your own template (duplicate existing one) or disk image

Warning: Please, be aware of the VMs you are running.

And if not used, suspend or terminate them...

- ❑ every 3 months, we'll recommend you your running VMs
 - if not explicitly renewed/extended in the defined time period, **the VMs will be terminated**

Other computing possibilities

Hadoop computing

Hadoop / MapReduce computing

Hadoop:

- an open-source framework for distributed storage and **distributed processing of large volumes of data**
 - large data blocks splitted and distributed amongst nodes
 - a MapReduce-based algorithm (= data processing code) is distributed over the distributed blocks and processed in parallel

Suitable for:

- huge datasets to be processed
 - but NOT suitable for arbitrary data processing one can imagine
 - just for the processing meeting the MapReduce programming model
 - e.g., counting the number of times words occur in a corpus

<https://wiki.metacentrum.cz/wiki/Kategorie:Hadoop>

Other computing possibilities

Specialized frontends – Galaxy, Chipster, ...

Specialized frontends/environments

Suitable for:

- user communities with well-defined processing needs
 - workload & computing pipeline orchestrators available via GUI
 - usually adapted to user needs and/or because of interoperability with our infrastructure
 - in background, the proper computing method is used (grid, cloud, etc.)

How to compute?

- **Galaxy** (docs <https://wiki.metacentrum.cz/wiki/Galaxy>)
 - *ELIXIR RepeatExplorer Galaxy* – <https://repeatexplorer-elixir.cerit-sc.cz>
 - *MetaCentrum Galaxy* – <https://galaxy.metacentrum.cz>
- **Chipster** (docs <https://wiki.metacentrum.cz/wiki/Chipster>)
 - <http://chipster.metacentrum.cz:8081>
- basic details are provided in the leaflet